

# **City of Scottsbluff, Nebraska**

**Monday, February 2, 2015**

**Regular Meeting**

## **Item Consent5**

**Council to approve bid specifications for Water District No. 105, Reganis Subdivision and authorize the City Clerk to advertise for bids to be received by February 24, 2015 at 2:00 p.m.**

**Staff Contact: Rick Kuckkahn, City Manager**

<b>Reganis Subdivision Water Line (Water District No. 105)</b>					
<b>City of Scottsbluff</b>					
<b>Bid Date: February 24, 2015 @ 2:00 PM</b>					
<b>No.</b>	<b>Description</b>	<b>Unit</b>	<b>Quantity</b>	<b>Unit Cost</b>	<b>Total</b>
1	Mobilization	LS	1	\$ 8,000.00	\$ 8,000.00
2	8" PVC Water Main	LF	1000	\$ 40.00	\$ 40,000.00
3	6" PVC Water Main	LF	120	\$ 30.00	\$ 3,600.00
4	8" NRS Gate Valve & Valve Box	EA	2	\$ 2,000.00	\$ 4,000.00
5	Fire Hydrant (5.5' Bury) w/ Auxiliary Valve & Valve Box	EA	2	\$ 4,000.00	\$ 8,000.00
6	Remove & Reset Fire Hydrant (5.5' Bury) w/ New Auxiliary Valve & Valve Box	EA	1	\$ 2,000.00	\$ 2,000.00
7	3" Service Connection	EA	1	\$ 1,000.00	\$ 1,000.00
8	2" Service Connection	EA	2	\$ 500.00	\$ 1,000.00
9	1" Service Connection	EA	7	\$ 300.00	\$ 2,100.00
10	3" Service Line	LF	30	\$ 25.00	\$ 750.00
11	2" Service Line	LF	50	\$ 20.00	\$ 1,000.00
12	1" Service Line	LF	280	\$ 17.00	\$ 4,760.00
13	Water Fittings	LBS	1800	\$ 5.00	9,000.00
14	Ball Locator	EA	30	\$ 35.00	\$ 1,050.00
			<b>Total</b>		<b>\$86,260.00</b>

Construction Costs =	<b>\$86,260.00</b>
Engineering =	<b>\$9,916.00</b>
Inspection =	<b>\$9,233.00</b>
<b>TOTAL COST =</b>	<b>\$105,409.00</b>



HUB-Zone certified firm

# ***SPECIFICATIONS***

## **Water District 105 Block 2, Reganis Subdivision and Block 1A, Scotts Bluff County College Tract**

### **City of Scottsbluff Scottsbluff, Nebraska**



**PREPARED FOR**  
City of Scottsbluff  
2525 Circle Drive  
Scottsbluff, NE 69361

**PREPARED BY**  
MC Schaff & Associates, INC  
818 S Beltline Highway E  
Scottsbluff, NE 69361  
(308) 635-1926

**PROJECT**  
RM140169-00  
January, 2015



SPECIFICATIONS INDEX

City of Scottsbluff

Water District 105 – Block 2, Reganis Subdivision and Block 1A, Scotts Bluff County  
College Tract

Description	Section
Advertisement for Bids	
Instructions to Bidders	200
Bid Form	410
Bid Bond	430
Notice of Award	510
Agreement	520
Notice to Proceed	550
Performance Bond	610
Payment Bond	615
Application for Payment	620
Certificate of Substantial Completion	625
General Conditions	700
Supplementary Conditions	800
Change Order	941
Pay Items	1000
Special Provisions	1010
Construction Surveying	1020
Water Main Distribution	2000
Maintenance	2900

# INSTRUCTIONS TO BIDDERS FOR CONSTRUCTION CONTRACTS

Prepared by

**ENGINEERS JOINT CONTRACT DOCUMENTS COMMITTEE**

and

Issued and Published Jointly by



AMERICAN COUNCIL OF ENGINEERING COMPANIES

ASSOCIATED GENERAL CONTRACTORS OF AMERICA

AMERICAN SOCIETY OF CIVIL ENGINEERS

PROFESSIONAL ENGINEERS IN PRIVATE PRACTICE  
*A Practice Division of the*  
NATIONAL SOCIETY OF PROFESSIONAL ENGINEERS

Endorsed by



CONSTRUCTION SPECIFICATIONS INSTITUTE

---

EJCDC C-200 Instructions to Bidders for Construction Contracts  
Copyright © 2007 National Society of Professional Engineers for EJCDC. All rights reserved.

---

Copyright © 2007 National Society of Professional Engineers  
1420 King Street, Alexandria, VA 22314-2794  
(703) 684-2882  
[www.nspe.org](http://www.nspe.org)

American Council of Engineering Companies  
1015 15th Street N.W., Washington, DC 20005  
(202) 347-7474  
[www.acec.org](http://www.acec.org)

American Society of Civil Engineers  
1801 Alexander Bell Drive, Reston, VA 20191-4400  
(800) 548-2723  
[www.asce.org](http://www.asce.org)

Associated General Contractors of America  
2300 Wilson Boulevard, Suite 400, Arlington, VA 22201-3308  
(703) 548-3118  
[www.agc.org](http://www.agc.org)

The copyright for this EJCDC document is owned jointly by the four  
EJCDC sponsoring organizations and held in trust for their benefit by NSPE.

# INSTRUCTIONS TO BIDDERS

## TABLE OF CONTENTS

	<b>Page</b>
Article 1 – Defined Terms.....	1
Article 2 – Copies of Bidding Documents.....	1
Article 3 – Qualifications of Bidders .....	1
Article 4 – Examination of Bidding Documents, Other Related Data, and Site .....	1
Article 5 – Pre-Bid Conference.....	4
Article 6 – Site and Other Areas .....	4
Article 7 – Interpretations and Addenda.....	5
Article 8 – Bid Security .....	5
Article 9 – Contract Times .....	5
Article 10 – Liquidated Damages .....	5
Article 11 – Substitute and “Or-Equal” Items .....	5
Article 12 – Subcontractors, Suppliers and Others .....	6
Article 13 – Preparation of Bid .....	6
Article 14 – Basis of Bid; Comparison of Bids .....	7
Article 15 – Submittal of Bid.....	8
Article 16 – Modification and Withdrawal of Bid .....	8
Article 17 – Opening of Bids .....	9
Article 18 – Bids to Remain Subject to Acceptance .....	9
Article 19 – Evaluation of Bids and Award of Contract .....	9
Article 20 – Contract Security and Insurance.....	9
Article 21 – Signing of Agreement.....	10

## ARTICLE 1 – DEFINED TERMS

1.01 Terms used in these Instructions to Bidders have the meanings indicated in the General Conditions and Supplementary Conditions. Additional terms used in these Instructions to Bidders have the meanings indicated below:

A. *Issuing Office* – The office from which the Bidding Documents are to be issued and where the bidding procedures are to be administered.

## ARTICLE 2 – COPIES OF BIDDING DOCUMENTS

2.01 Complete sets of the Bidding Documents in the number and for the deposit sum, if any, stated in the advertisement or invitation to bid may be obtained from the Issuing Office. ~~The deposit will be refunded to each document holder of record who returns a complete set of Bidding Documents in good condition within 30 days after opening of Bids.~~

2.02 Complete sets of Bidding Documents shall be used in preparing Bids; neither Owner nor Engineer assumes any responsibility for errors or misinterpretations resulting from the use of incomplete sets of Bidding Documents.

2.03 Owner and Engineer, in making copies of Bidding Documents available on the above terms, do so only for the purpose of obtaining Bids for the Work and do not authorize or confer a license for any other use.

## ARTICLE 3 – QUALIFICATIONS OF BIDDERS

3.01 To demonstrate Bidder's qualifications to perform the Work, within **five** days of Owner's request, Bidder shall submit written evidence such as financial data, previous experience, present commitments, and such other data as may be called for below.

A. **A list of five similar projects and the primary contact's name and phone number.**

3.02 Bidder is advised to carefully review those portions of the Bid Form requiring Bidder's representations and certifications.

## ARTICLE 4 – EXAMINATION OF BIDDING DOCUMENTS, OTHER RELATED DATA, AND SITE

4.01 *Subsurface and Physical Conditions*

A. The Supplementary Conditions identify:

1. Those reports known to Owner of explorations and tests of subsurface conditions at or contiguous to the Site.
2. Those drawings known to Owner of physical conditions relating to existing surface or subsurface structures at the Site (except Underground Facilities).



- B. Copies of reports and drawings referenced in Paragraph 4.01.A will be made available by Owner to any Bidder on request. Those reports and drawings are not part of the Contract Documents, but the “technical data” contained therein upon which Bidder is entitled to rely as provided in Paragraph 4.02 of the General Conditions has been identified and established in Paragraph 4.02 of the Supplementary Conditions. Bidder is responsible for any interpretation or conclusion Bidder draws from any “technical data” or any other data, interpretations, opinions, or information contained in such reports or shown or indicated in such drawings.

4.02 *Underground Facilities*

- A. Information and data shown or indicated in the Bidding Documents with respect to existing Underground Facilities at or contiguous to the Site is based upon information and data furnished to Owner and Engineer by owners of such Underground Facilities, including Owner, or others.

4.03 *Hazardous Environmental Condition*

- A. The Supplementary Conditions identify any reports and drawings known to Owner relating to a Hazardous Environmental Condition identified at the Site.
- B. Copies of reports and drawings referenced in Paragraph 4.03.A will be made available by Owner to any Bidder on request. Those reports and drawings are not part of the Contract Documents, but the “technical data” contained therein upon which Bidder is entitled to rely as provided in Paragraph 4.06 of the General Conditions has been identified and established in Paragraph 4.06 of the Supplementary Conditions. Bidder is responsible for any interpretation or conclusion Bidder draws from any “technical data” or any other data, interpretations, opinions, or information contained in such reports or shown or indicated in such drawings.

- 4.04 Provisions concerning responsibilities for the adequacy of data furnished to prospective Bidders with respect to subsurface conditions, other physical conditions, and Underground Facilities, and possible changes in the Bidding Documents due to differing or unanticipated subsurface or physical conditions appear in Paragraphs 4.02, 4.03, and 4.04 of the General Conditions. Provisions concerning responsibilities for the adequacy of data furnished to prospective Bidders with respect to a Hazardous Environmental Condition at the Site, if any, and possible changes in the Contract Documents due to any Hazardous Environmental Condition uncovered or revealed at the Site which was not shown or indicated in the Drawings or Specifications or identified in the Contract Documents to be within the scope of the Work, appear in Paragraph 4.06 of the General Conditions.

- 4.05 On request, Owner will provide Bidder access to the Site to conduct such examinations, investigations, explorations, tests, and studies as Bidder deems necessary for submission of a Bid. Bidder shall fill all holes and clean up and restore the Site to its former condition upon completion of such explorations, investigations, tests, and studies. Bidder shall comply with all applicable Laws and Regulations relative to excavation and utility locates.

- 4.06 A. Reference is made to Article 7 of the Supplementary Conditions for the identification of the general nature of other work that is to be performed at the Site by Owner or others (such as utilities and other prime contractors) that relates to the Work contemplated by these Bidding

Documents. On request, Owner will provide to each Bidder for examination access to or copies of contract documents (other than portions thereof related to price) for such other work.

- B. Paragraph 6.13.C of the General Conditions indicates that if an Owner safety program exists, it will be noted in the Supplementary Conditions.

4.07 It is the responsibility of each Bidder before submitting a Bid to:

- A. examine and carefully study the Bidding Documents, and the other related data identified in the Bidding Documents;
- B. visit the Site and become familiar with and satisfy Bidder as to the general, local, and Site conditions that may affect cost, progress, and performance of the Work;
- C. become familiar with and satisfy Bidder as to all federal, state, and local Laws and Regulations that may affect cost, progress, and performance of the Work;
- D. carefully study all: (1) reports of explorations and tests of subsurface conditions at or contiguous to the Site and all drawings of physical conditions relating to existing surface or subsurface structures at the Site (except Underground Facilities) that have been identified in Paragraph 4.02 of the Supplementary Conditions as containing reliable "technical data," and (2) reports and drawings of Hazardous Environmental Conditions, if any, at the Site that have been identified in the Paragraph 4.06 of the Supplementary Conditions as containing reliable "technical data";
- E. consider the information known to Bidder; information commonly known to contractors doing business in the locality of the Site; information and observations obtained from visits to the Site; the Bidding Documents; and the Site-related reports and drawings identified in the Bidding Documents, with respect to the effect of such information, observations, and documents on (1) the cost, progress, and performance of the Work; (2) the means, methods, techniques, sequences, and procedures of construction to be employed by Bidder, including applying any specific means, methods, techniques, sequences, and procedures of construction expressly required by the Bidding Documents; and (3) Bidder's safety precautions and programs;
- F. agree at the time of submitting its Bid that no further examinations, investigations, explorations, tests, studies, or data are necessary for the determination of its Bid for performance of the Work at the price(s) bid and within the times required, and in accordance with the other terms and conditions of the Bidding Documents;
- G. become aware of the general nature of the work to be performed by Owner and others at the Site that relates to the Work as indicated in the Bidding Documents;
- H. promptly give Engineer written notice of all conflicts, errors, ambiguities, or discrepancies that Bidder discovers in the Bidding Documents and confirm that the written resolution thereof by Engineer is acceptable to Bidder; and

I. determine that the Bidding Documents are generally sufficient to indicate and convey understanding of all terms and conditions for the performance of the Work.

4.08 The submission of a Bid will constitute an incontrovertible representation by Bidder that Bidder has complied with every requirement of this Article 4, that without exception the Bid is premised upon performing and furnishing the Work required by the Bidding Documents and applying any specific means, methods, techniques, sequences, and procedures of construction that may be shown or indicated or expressly required by the Bidding Documents, that Bidder has given Engineer written notice of all conflicts, errors, ambiguities, and discrepancies that Bidder has discovered in the Bidding Documents and the written resolutions thereof by Engineer are acceptable to Bidder, and that the Bidding Documents are generally sufficient to indicate and convey understanding of all terms and conditions for performing and furnishing the Work.

#### **ARTICLE 5 – PRE-BID CONFERENCE**

~~5.01 A pre Bid conference will be held at \_\_\_\_\_ [a.m.][p.m.] local time on \_\_\_\_\_ at \_\_\_\_\_. Representatives of Owner and Engineer will be present to discuss the Project. Bidders are [required] [encouraged] to attend and participate in the conference. Engineer will transmit to all prospective Bidders of record such Addenda as Engineer considers necessary in response to questions arising at the conference. Oral statements may not be relied upon and will not be binding or legally effective.~~

#### **ARTICLE 6 – SITE AND OTHER AREAS**

6.01 The Site is identified in the Bidding Documents. Easements for permanent structures or permanent changes in existing facilities are to be obtained and paid for by Owner unless otherwise provided in the Bidding Documents. All additional lands and access thereto required for temporary construction facilities, construction equipment, or storage of materials and equipment to be incorporated in the Work are to be obtained and paid for by Contractor.

## **ARTICLE 7 – INTERPRETATIONS AND ADDENDA**

- 7.01 All questions about the meaning or intent of the Bidding Documents are to be submitted to Engineer in writing. Interpretations or clarifications considered necessary by Engineer in response to such questions will be issued by Addenda mailed or delivered to all parties recorded by Engineer as having received the Bidding Documents. Questions received less than ten days prior to the date for opening of Bids may not be answered. Only questions answered by Addenda will be binding. Oral and other interpretations or clarifications will be without legal effect.
- 7.02 Addenda may be issued to clarify, correct, or change the Bidding Documents as deemed advisable by Owner or Engineer.

## **ARTICLE 8 – BID SECURITY**

- 8.01 A Bid must be accompanied by Bid security made payable to Owner in an amount of 5 percent of Bidder's maximum Bid price and in the form of a certified check, bank money order, or a Bid bond (on the form attached) issued by a surety meeting the requirements of Paragraphs 5.01 and 5.02 of the General Conditions.
- 8.02 The Bid security of the Successful Bidder will be retained until such Bidder has executed the Contract Documents, furnished the required contract security and met the other conditions of the Notice of Award, whereupon the Bid security will be returned. If the Successful Bidder fails to execute and deliver the Contract Documents and furnish the required contract security within 15 days after the Notice of Award, Owner may consider Bidder to be in default, annul the Notice of Award, and the Bid security of that Bidder will be forfeited. Such forfeiture shall be Owner's exclusive remedy if Bidder defaults. The Bid security of other Bidders whom Owner believes to have a reasonable chance of receiving the award may be retained by Owner until the earlier of seven days after the Effective Date of the Agreement or 61 days after the Bid opening, whereupon Bid security furnished by such Bidders will be returned.
- 8.03 Bid security of other Bidders whom Owner believes do not have a reasonable chance of receiving the award will be returned within seven days after the Bid opening.

## **ARTICLE 9 – CONTRACT TIMES**

- 9.01 The number of days within which, or the dates by which, [~~Milestones are to be achieved and~~] the Work is to be substantially completed and ready for final payment are set forth in the Agreement.

## **ARTICLE 10 – LIQUIDATED DAMAGES**

- 10.01 Provisions for liquidated damages, if any, are set forth in the Agreement.

## **ARTICLE 11 – SUBSTITUTE AND “OR-EQUAL” ITEMS**

- 11.01 The Contract, if awarded, will be on the basis of materials and equipment specified or described in the Bidding Documents, or those substitute or “or-equal” materials and equipment approved by Engineer and identified by Addendum. The materials and equipment described in the Bidding Documents establish a standard of required type, function and quality to be met by any proposed

substitute or “or-equal” item. No item of material or equipment will be considered by Engineer as a substitute or “or-equal” unless written request for approval has been submitted by Bidder and has been received by Engineer at least 15 days prior to the date for receipt of Bids. Each such request shall conform to the requirements of Paragraph 6.05 of the General Conditions. The burden of proof of the merit of the proposed item is upon Bidder. Engineer’s decision of approval or disapproval of a proposed item will be final. If Engineer approves any proposed item, such approval will be set forth in an Addendum issued to all prospective Bidders. Bidders shall not rely upon approvals made in any other manner.

## **ARTICLE 12 – SUBCONTRACTORS, SUPPLIERS AND OTHERS**

- 12.01 If the Supplementary Conditions require the identity of certain Subcontractors, Suppliers, individuals, or entities to be submitted to Owner in advance of a specified date prior to the Effective Date of the Agreement, the apparent Successful Bidder, and any other Bidder so requested, shall within five days after Bid opening, submit to Owner a list of all such Subcontractors, Suppliers, individuals, or entities proposed for those portions of the Work for which such identification is required. Such list shall be accompanied by an experience statement with pertinent information regarding similar projects and other evidence of qualification for each such Subcontractor, Supplier, individual, or entity if requested by Owner. If Owner or Engineer, after due investigation, has reasonable objection to any proposed Subcontractor, Supplier, individual, or entity, Owner may, before the Notice of Award is given, request apparent Successful Bidder to submit a substitute, without an increase in the Bid.
- 12.02 If apparent Successful Bidder declines to make any such substitution, Owner may award the Contract to the next lowest Bidder that proposes to use acceptable Subcontractors, Suppliers, individuals, or entities. Declining to make requested substitutions will not constitute grounds for forfeiture of the Bid security of any Bidder. Any Subcontractor, Supplier, individual, or entity so listed and against which Owner or Engineer makes no written objection prior to the giving of the Notice of Award will be deemed acceptable to Owner and Engineer subject to revocation of such acceptance after the Effective Date of the Agreement as provided in Paragraph 6.06 of the General Conditions.
- 12.03 Contractor shall not be required to employ any Subcontractor, Supplier, individual, or entity against whom Contractor has reasonable objection.

## **ARTICLE 13 – PREPARATION OF BID**

- 13.01 The Bid Form is included with the Bidding Documents. Additional copies may be obtained from Engineer.
- 13.02 All blanks on the Bid Form shall be completed in ink and the Bid Form signed in ink. Erasures or alterations shall be initialed in ink by the person signing the Bid Form. A Bid price shall be indicated for each Bid item, alternative, adjustment unit price item, and unit price item listed therein. In the case of optional alternatives the words “No Bid,” “No Change,” or “Not Applicable” may be entered.
- 13.03 A Bid by a corporation shall be executed in the corporate name by the president or a vice-president or other corporate officer accompanied by evidence of authority to sign. The corporate

seal shall be affixed and attested by the secretary or an assistant secretary. The corporate address and state of incorporation shall be shown.

- 13.04 A Bid by a partnership shall be executed in the partnership name and signed by a partner (whose title must appear under the signature), accompanied by evidence of authority to sign. The official address of the partnership shall be shown.
- 13.05 A Bid by a limited liability company shall be executed in the name of the firm by a member and accompanied by evidence of authority to sign. The state of formation of the firm and the official address of the firm shall be shown.
- 13.06 A Bid by an individual shall show the Bidder's name and official address.
- 13.07 A Bid by a joint venture shall be executed by each joint venturer in the manner indicated on the Bid Form. The official address of the joint venture shall be shown.
- 13.08 All names shall be printed in ink below the signatures.
- 13.09 The Bid shall contain an acknowledgment of receipt of all Addenda, the numbers of which shall be filled in on the Bid Form.
- 13.10 Postal and e-mail addresses and telephone number for communications regarding the Bid shall be shown.
- 13.11 The Bid shall contain evidence of Bidder's authority and qualification to do business in the state where the Project is located, or Bidder shall covenant in writing to obtain such authority and qualification prior to award of the Contract and attach such covenant to the Bid. Bidder's state contractor license number, if any, shall also be shown on the Bid Form.

#### **ARTICLE 14 – BASIS OF BID; COMPARISON OF BIDS**

##### 14.01 *Lump Sum*

- A. Bidders shall submit a Bid on a lump sum basis as set forth in the Bid Form.

##### 14.02 *Unit Price*

- A. Bidders shall submit a Bid on a unit price basis for each item of Work listed in the Bid schedule.
- B. The total of all estimated prices will be the sum of the products of the estimated quantity of each item and the corresponding unit price. The final quantities and Contract Price will be determined in accordance with Paragraph 11.03 of the General Conditions.
- C. Discrepancies between the multiplication of units of Work and unit prices will be resolved in favor of the unit prices. Discrepancies between the indicated sum of any column of figures and the correct sum thereof will be resolved in favor of the correct sum.

#### 14.03 Allowances

- A. For cash allowances the Bid price shall include such amounts as the Bidder deems proper for Contractor's overhead, costs, profit, and other expenses on account of cash allowances, if any, named in the Contract Documents, in accordance with Paragraph 11.02.B of the General Conditions.

#### 14.04 Completion Time Comparisons

- A. Bid prices will be compared after adjusting for differences in the time designated by Bidders for Substantial Completion. The adjusting amount will be determined at the rate set forth in the Contract Documents for liquidated damages for failing to achieve Substantial Completion for each day before or after the desired date appearing in Article 9 above.

### **ARTICLE 15 – SUBMITTAL OF BID**

15.01 With each copy of the Bidding Documents, a Bidder is furnished one separate unbound copy of the Bid Form, and, if required, the Bid Bond Form. The unbound copy of the Bid Form is to be completed and submitted with the Bid security and the following documents:

15.02 A Bid shall be submitted no later than the date and time prescribed and at the place indicated in the advertisement or invitation to bid and shall be enclosed in a plainly marked package with the Project title (and, if applicable, the designated portion of the Project for which the Bid is submitted), the name and address of Bidder, and shall be accompanied by the Bid security and other required documents. If a Bid is sent by mail or other delivery system, the sealed envelope containing the Bid shall be enclosed in a separate package plainly marked on the outside with the notation "BID ENCLOSED." A mailed Bid shall be addressed to Owner at the address in Article 1.01 of the Bid Form.

### **ARTICLE 16 – MODIFICATION AND WITHDRAWAL OF BID**

16.01 A Bid may be modified or withdrawn by an appropriate document duly executed in the same manner that a Bid must be executed and delivered to the place where Bids are to be submitted prior to the date and time for the opening of Bids.

16.02 If within 24 hours after Bids are opened any Bidder files a duly signed written notice with Owner and promptly thereafter demonstrates to the reasonable satisfaction of Owner that there was a material and substantial mistake in the preparation of its Bid, that Bidder may withdraw its Bid, and the Bid security will be returned. Thereafter, if the Work is rebid, that Bidder will be disqualified from further bidding on the Work.

## **ARTICLE 17 – OPENING OF BIDS**

17.01 Bids will be opened at the time and place indicated in the Advertisement or Invitation to Bid and, unless obviously non-responsive, read aloud publicly. An abstract of the amounts of the base Bids and major alternates, if any, will be made available to Bidders after the opening of Bids.

## **ARTICLE 18 – BIDS TO REMAIN SUBJECT TO ACCEPTANCE**

18.01 All Bids will remain subject to acceptance for the period of time stated in the Bid Form, but Owner may, in its sole discretion, release any Bid and return the Bid security prior to the end of this period.

## **ARTICLE 19 – EVALUATION OF BIDS AND AWARD OF CONTRACT**

19.01 Owner reserves the right to reject any or all Bids, including without limitation, nonconforming, nonresponsive, unbalanced, or conditional Bids. Owner further reserves the right to reject the Bid of any Bidder whom it finds, after reasonable inquiry and evaluation, to not be responsible. Owner may also reject the Bid of any Bidder if Owner believes that it would not be in the best interest of the Project to make an award to that Bidder. Owner also reserves the right to waive all informalities not involving price, time, or changes in the Work and to negotiate contract terms with the Successful Bidder.

19.02 More than one Bid for the same Work from an individual or entity under the same or different names will not be considered. Reasonable grounds for believing that any Bidder has an interest in more than one Bid for the Work may be cause for disqualification of that Bidder and the rejection of all Bids in which that Bidder has an interest.

19.03 In evaluating Bids, Owner will consider whether or not the Bids comply with the prescribed requirements, and such alternates, unit prices and other data, as may be requested in the Bid Form or prior to the Notice of Award.

19.04 In evaluating Bidders, Owner will consider the qualifications of Bidders and may consider the qualifications and experience of Subcontractors, Suppliers, and other individuals or entities proposed for those portions of the Work for which the identity of Subcontractors, Suppliers, and other individuals or entities must be submitted as provided in the Supplementary Conditions.

19.05 Owner may conduct such investigations as Owner deems necessary to establish the responsibility, qualifications, and financial ability of Bidders, proposed Subcontractors, Suppliers, individuals, or entities proposed for those portions of the Work in accordance with the Contract Documents.

19.06 If the Contract is to be awarded, Owner will award the Contract to the Bidder whose Bid is in the best interests of the Project.

## **ARTICLE 20 – CONTRACT SECURITY AND INSURANCE**

20.01 Article 5 of the General Conditions, as may be modified by the Supplementary Conditions, sets forth Owner's requirements as to performance and payment bonds and insurance. When the



Successful Bidder delivers the executed Agreement to Owner, it shall be accompanied by such bonds.

## **ARTICLE 21 – SIGNING OF AGREEMENT**

21.01 When Owner issues a Notice of Award to the Successful Bidder, it shall be accompanied by the required number of unsigned counterparts of the Agreement along with the other Contract Documents which are identified in the Agreement as attached thereto. Within 15 days thereafter, Successful Bidder shall sign and deliver the required number of counterparts of the Agreement and attached documents to Owner. Within ten days thereafter, Owner shall deliver one fully signed counterpart to Successful Bidder with a complete set of the Drawings with appropriate identification.

# BID FORM FOR CONSTRUCTION CONTRACTS

Prepared by

**ENGINEERS JOINT CONTRACT DOCUMENTS COMMITTEE**

and

Issued and Published Jointly by



AMERICAN COUNCIL OF ENGINEERING COMPANIES

ASSOCIATED GENERAL CONTRACTORS OF AMERICA

AMERICAN SOCIETY OF CIVIL ENGINEERS

PROFESSIONAL ENGINEERS IN PRIVATE PRACTICE  
*A Practice Division of the*  
NATIONAL SOCIETY OF PROFESSIONAL ENGINEERS

Endorsed by



CONSTRUCTION SPECIFICATIONS INSTITUTE

---

EJCDC C-410 Bid Form for Construction Contracts  
Copyright © 2007 National Society of Professional Engineers for EJCDC. All rights reserved.

---

Copyright © 2007 National Society of Professional Engineers  
1420 King Street, Alexandria, VA 22314-2794  
(703) 684-2882  
[www.nspe.org](http://www.nspe.org)

American Council of Engineering Companies  
1015 15th Street N.W., Washington, DC 20005  
(202) 347-7474  
[www.acec.org](http://www.acec.org)

American Society of Civil Engineers  
1801 Alexander Bell Drive, Reston, VA 20191-4400  
(800) 548-2723  
[www.asce.org](http://www.asce.org)

Associated General Contractors of America  
2300 Wilson Boulevard, Suite 400, Arlington, VA 22201-3308  
(703) 548-3118  
[www.agc.org](http://www.agc.org)

The copyright for this EJCDC document is owned jointly by the four  
EJCDC sponsoring organizations and held in trust for their benefit by NSPE.

**BID FORM**

Water District 105 – Block 2, Reganis Subdivision and Block 1A, Scotts Bluff County College Tract  
Scottsbluff, Nebraska

**TABLE OF CONTENTS**

	<b>Page</b>
Article 1 – Bid Recipient.....	1
Article 2 – Bidder’s Acknowledgements.....	1
Article 3 – Bidder’s Representations .....	1
Article 4 – Bidder’s Certification.....	2
Article 5 – Basis of Bid .....	3
Article 6 – Time of Completion.....	4
Article 7 – Attachments to This Bid .....	4
Article 8 – Defined Terms.....	4
Article 9 – Bid Submittal.....	5

**ARTICLE 1 – BID RECIPIENT**

1.01 This Bid is submitted to:

City of Scottsbluff  
2525 Circle Drive  
Scottsbluff, NE 69361

1.02 The undersigned Bidder proposes and agrees, if this Bid is accepted, to enter into an Agreement with Owner in the form included in the Bidding Documents to perform all Work as specified or indicated in the Bidding Documents for the prices and within the times indicated in this Bid and in accordance with the other terms and conditions of the Bidding Documents.

**ARTICLE 2 – BIDDER’S ACKNOWLEDGEMENTS**

2.01 Bidder accepts all of the terms and conditions of the Instructions to Bidders, including without limitation those dealing with the disposition of Bid security. This Bid will remain subject to acceptance for 60 days after the Bid opening, or for such longer period of time that Bidder may agree to in writing upon request of Owner.

**ARTICLE 3 – BIDDER’S REPRESENTATIONS**

3.01 In submitting this Bid, Bidder represents that:

A. Bidder has examined and carefully studied the Bidding Documents, other related data identified in the Bidding Documents, and the following Addenda, receipt of which is hereby acknowledged:

<u>Addendum No.</u>	<u>Addendum Date</u>
_____	_____
_____	_____
_____	_____

B. Bidder has visited the Site and become familiar with and is satisfied as to the general, local, and Site conditions that may affect cost, progress, and performance of the Work.

C. Bidder is familiar with and is satisfied as to all Laws and Regulations that may affect cost, progress, and performance of the Work.

D. Bidder has carefully studied all: (1) reports of explorations and tests of subsurface conditions at or contiguous to the Site and all drawings of physical conditions relating to existing surface or subsurface structures at the Site (except Underground Facilities) that have been identified in SC-4.02 as containing reliable "technical data," and (2) reports and drawings of Hazardous Environmental Conditions, if any, at the Site that have been identified in SC-4.06 as containing reliable "technical data."

E. Bidder has considered the information known to Bidder; information commonly known to contractors doing business in the locality of the Site; information and observations obtained from visits to the Site; the Bidding Documents; and the Site-related reports and drawings

identified in the Bidding Documents, with respect to the effect of such information, observations, and documents on (1) the cost, progress, and performance of the Work; (2) the means, methods, techniques, sequences, and procedures of construction to be employed by Bidder, including applying the specific means, methods, techniques, sequences, and procedures of construction expressly required by the Bidding Documents; and (3) Bidder's safety precautions and programs.

- F. Based on the information and observations referred to in Paragraph 3.01.E above, Bidder does not consider that further examinations, investigations, explorations, tests, studies, or data are necessary for the determination of this Bid for performance of the Work at the price(s) bid and within the times required, and in accordance with the other terms and conditions of the Bidding Documents.
- G. Bidder is aware of the general nature of work to be performed by Owner and others at the Site that relates to the Work as indicated in the Bidding Documents.
- H. Bidder has given Engineer written notice of all conflicts, errors, ambiguities, or discrepancies that Bidder has discovered in the Bidding Documents, and the written resolution thereof by Engineer is acceptable to Bidder.
- 1. The Bidding Documents are generally sufficient to indicate and convey understanding of all terms and conditions for the performance of the Work for which this Bid is submitted.

#### **ARTICLE 4 – BIDDER'S CERTIFICATION**

4.01 Bidder certifies that:

- A. This Bid is genuine and not made in the interest of or on behalf of any undisclosed individual or entity and is not submitted in conformity with any collusive agreement or rules of any group, association, organization, or corporation;
- B. Bidder has not directly or indirectly induced or solicited any other Bidder to submit a false or sham Bid;
- C. Bidder has not solicited or induced any individual or entity to refrain from bidding; and
- D. Bidder has not engaged in corrupt, fraudulent, collusive, or coercive practices in competing for the Contract. For the purposes of this Paragraph 4.01.D:
  - 1. "corrupt practice" means the offering, giving, receiving, or soliciting of anything of value likely to influence the action of a public official in the bidding process;
  - 2. "fraudulent practice" means an intentional misrepresentation of facts made (a) to influence the bidding process to the detriment of Owner, (b) to establish bid prices at artificial non-competitive levels, or (c) to deprive Owner of the benefits of free and open competition;

3. "collusive practice" means a scheme or arrangement between two or more Bidders, with or without the knowledge of Owner, a purpose of which is to establish bid prices at artificial, non-competitive levels; and
4. "coercive practice" means harming or threatening to harm, directly or indirectly, persons or their property to influence their participation in the bidding process or affect the execution of the Contract.

**ARTICLE 5 – BASIS OF BID**

Bidder will complete the Work in accordance with the Contract Documents for the following price(s):

<u>Item</u>	<u>Description</u>	<u>Estimated Quantity</u>	<u>Unit</u>	<u>Unit Price</u>	<u>Total Estimated Price</u>
1	Mobilization	1	LS	\$ _____	\$ _____
2	8" PVC Waterline	1,000	LF	\$ _____	\$ _____
3	6" PVC Waterline	120	LF	\$ _____	\$ _____
4	8" Water Valve and Valve Box	2	EA	\$ _____	\$ _____
5	Fire Hydrant w/ Auxiliary Valve & Valve Box	2	EA	\$ _____	\$ _____
6	Remove & Reset Fire Hydrant w/ New Auxiliary Valve & Valve Box	1	EA	\$ _____	\$ _____
7	3" Service Connection	1	EA	\$ _____	\$ _____
8	2" Service Connection	2	EA	\$ _____	\$ _____
9	1" Service Connection	7	EA	\$ _____	\$ _____
10	3" Service Line	30	LF	\$ _____	\$ _____
11	2" Service Line	50	LF	\$ _____	\$ _____
12	1" Service Line	280	LF	\$ _____	\$ _____
13	Fittings	1,800	LBS	\$ _____	\$ _____
14	Ball Locator	30	EA	\$ _____	\$ _____

Unit Prices have been computed in accordance with Paragraph 11.03.B of the General Conditions.

Bidder acknowledges that estimated quantities are not guaranteed, and are solely for the purpose of comparison of Bids, and final payment for all unit price Bid items will be based on actual quantities, determined as provided in the Contract Documents.

**ARTICLE 6 – TIME OF COMPLETION**

- 6.01 Bidder agrees that the Work will be substantially complete and will be completed and ready for final payment in accordance with Paragraph 14.07 of the General Conditions on or before the dates or within the number of calendar days indicated in the Agreement.
- 6.02 Bidder accepts the provisions of the Agreement as to liquidated damages.

**ARTICLE 7 – ATTACHMENTS TO THIS BID**

- 7.01 The following documents are submitted with and made a condition of this Bid:
  - A. Required Bid security in the form of a Bid Bond (EJCDC No. C-430) or Certified Check (circle type of security provided);
  - B. List of Project References;

**ARTICLE 8 – DEFINED TERMS**

- 8.01 The terms used in this Bid with initial capital letters have the meanings stated in the Instructions to Bidders, the General Conditions, and the Supplementary Conditions.



**ARTICLE 9 – BID SUBMITTAL**

9.01 This Bid is submitted by:

If Bidder is:

An Individual

Name (typed or printed): \_\_\_\_\_

By: \_\_\_\_\_  
(Individual's signature)

Doing business as: \_\_\_\_\_

A Partnership

Partnership Name: \_\_\_\_\_

By: \_\_\_\_\_  
(Signature of general partner -- attach evidence of authority to sign)

Name (typed or printed): \_\_\_\_\_

A Corporation

Corporation Name: \_\_\_\_\_ (SEAL)

State of Incorporation: \_\_\_\_\_

Type (General Business, Professional, Service, Limited Liability): \_\_\_\_\_

By: \_\_\_\_\_  
(Signature -- attach evidence of authority to sign)

Name (typed or printed): \_\_\_\_\_

Title: \_\_\_\_\_  
(CORPORATE SEAL)

Attest \_\_\_\_\_

Date of Qualification to do business in NEBRASKA is \_\_\_\_/\_\_\_\_/\_\_\_\_.

A Joint Venture

Name of Joint Venture: \_\_\_\_\_

First Joint Venturer Name: \_\_\_\_\_ (SEAL)

By: \_\_\_\_\_  
(Signature of first joint venture partner -- attach evidence of authority to sign)

Name (typed or printed): \_\_\_\_\_

Title: \_\_\_\_\_

Second Joint Venturer Name: \_\_\_\_\_ (SEAL)

By: \_\_\_\_\_  
(Signature of second joint venture partner -- attach evidence of authority to sign)

Name (typed or printed): \_\_\_\_\_

Title: \_\_\_\_\_

(Each joint venturer must sign. The manner of signing for each individual, partnership, and corporation that is a party to the joint venture should be in the manner indicated above.)

**Bidder's Business Address** \_\_\_\_\_

**Phone No.** \_\_\_\_\_ **Fax No.** \_\_\_\_\_

**E-mail** \_\_\_\_\_

**SUBMITTED on** \_\_\_\_\_, **20**\_\_\_\_\_.

**State Contractor License No.** \_\_\_\_\_ *[If applicable]*

**BID BOND**

Any singular reference to Bidder, Surety, Owner or other party shall be considered plural where applicable.

BIDDER *(Name and Address):*

SURETY *(Name and Address of Principal Place of Business):*

OWNER *(Name and Address):*

City of Scottsbluff  
2525 Circle Drive  
Scottsbluff, NE 69361

BID

Bid Due Date: February 24, 2015 at 2:00 P.M.  
Description: Water District 105 – Scottsbluff, NE

BOND

Bond Number:  
Date *(Not earlier than Bid due date):*  
Penal sum \_\_\_\_\_

(Words)

\$

(Figures)

Surety and Bidder, intending to be legally bound hereby, subject to the terms set forth below, do each cause this Bid Bond to be duly executed by an authorized officer, agent, or representative.

**BIDDER**

**SURETY**

\_\_\_\_\_  
Bidder's Name and Corporate Seal (Seal)

\_\_\_\_\_  
Surety's Name and Corporate Seal (Seal)

By: \_\_\_\_\_  
Signature

By: \_\_\_\_\_  
Signature (Attach Power of Attorney)

\_\_\_\_\_  
Print Name

\_\_\_\_\_  
Print Name

\_\_\_\_\_  
Title

\_\_\_\_\_  
Title

Attest: \_\_\_\_\_  
Signature

Attest: \_\_\_\_\_  
Signature

\_\_\_\_\_  
Title

\_\_\_\_\_  
Title

*Note: Above addresses are to be used for giving any required notice. Provide execution by any additional parties, such as joint venturers, if necessary.*

1. Bidder and Surety, jointly and severally, bind themselves, their heirs, executors, administrators, successors, and assigns to pay to Owner upon default of Bidder the penal sum set forth on the face of this Bond. Payment of the penal sum is the extent of Bidder's and Surety's liability. Recovery of such penal sum under the terms of this Bond shall be Owner's sole and exclusive remedy upon default of Bidder.
2. Default of Bidder shall occur upon the failure of Bidder to deliver within the time required by the Bidding Documents (or any extension thereof agreed to in writing by Owner) the executed Agreement required by the Bidding Documents and any performance and payment bonds required by the Bidding Documents.
3. This obligation shall be null and void if:
  - 3.1 Owner accepts Bidder's Bid and Bidder delivers within the time required by the Bidding Documents (or any extension thereof agreed to in writing by Owner) the executed Agreement required by the Bidding Documents and any performance and payment bonds required by the Bidding Documents, or
  - 3.2 All Bids are rejected by Owner, or
  - 3.3 Owner fails to issue a Notice of Award to Bidder within the time specified in the Bidding Documents (or any extension thereof agreed to in writing by Bidder and, if applicable, consented to by Surety when required by Paragraph 5 hereof).
4. Payment under this Bond will be due and payable upon default of Bidder and within 30 calendar days after receipt by Bidder and Surety of written notice of default from Owner, which notice will be given with reasonable promptness, identifying this Bond and the Project and including a statement of the amount due.
5. Surety waives notice of any and all defenses based on or arising out of any time extension to issue Notice of Award agreed to in writing by Owner and Bidder, provided that the total time for issuing Notice of Award including extensions shall not in the aggregate exceed 120 days from Bid due date without Surety's written consent.
6. No suit or action shall be commenced under this Bond prior to 30 calendar days after the notice of default required in Paragraph 4 above is received by Bidder and Surety and in no case later than one year after Bid due date.
7. Any suit or action under this Bond shall be commenced only in a court of competent jurisdiction located in the state in which the Project is located.
8. Notices required hereunder shall be in writing and sent to Bidder and Surety at their respective addresses shown on the face of this Bond. Such notices may be sent by personal delivery, commercial courier, or by United States Registered or Certified Mail, return receipt requested, postage pre-paid, and shall be deemed to be effective upon receipt by the party concerned.
9. Surety shall cause to be attached to this Bond a current and effective Power of Attorney evidencing the authority of the officer, agent, or representative who executed this Bond on behalf of Surety to execute, seal, and deliver such Bond and bind the Surety thereby.
10. This Bond is intended to conform to all applicable statutory requirements. Any applicable requirement of any applicable statute that has been omitted from this Bond shall be deemed to be included herein as if set forth at length. If any provision of this Bond conflicts with any applicable statute, then the provision of said statute shall govern and the remainder of this Bond that is not in conflict therewith shall continue in full force and effect.
11. The term "Bid" as used herein includes a Bid, offer, or proposal as applicable.

# Notice of Award

Date: \_\_\_\_\_

Project: Water District 105 – Scottsbluff, NE

Owner: City of Scottsbluff, Nebraska

Owner's Contract No.:

Contract:

Engineer's Project No.: RM140169-00

Bidder:

Bidder's Address: *[send Notice of Award Certified Mail, Return Receipt Requested]*

You are notified that your Bid dated \_\_\_\_\_ for the above Contract has been considered. You are the Successful Bidder and are awarded a Contract for \_\_\_\_\_

*[Indicate total Work, alternates, or sections of Work awarded.]*

The Contract Price of your Contract is \_\_\_\_\_ Dollars (\$\_\_\_\_\_).

*[Insert appropriate data if unit prices are used. Change language for cost-plus contracts.]*

\_\_\_\_\_ copies of the proposed Contract Documents (except Drawings) accompany this Notice of Award.

\_\_\_\_\_ sets of the Drawings will be delivered separately or otherwise made available to you immediately.

You must comply with the following conditions precedent within [15] days of the date you receive this Notice of Award.

1. Deliver to the Owner [\_\_\_\_\_] fully executed counterparts of the Contract Documents.
2. Deliver with the executed Contract Documents the Contract security [Bonds] as specified in the Instructions to Bidders (Article 20), General Conditions (Paragraph 5.01), and Supplementary Conditions (Paragraph SC-5.01).
3. Other conditions precedent:  
\_\_\_\_\_

Failure to comply with these conditions within the time specified will entitle Owner to consider you in default, annul this Notice of Award, and declare your Bid security forfeited.

Within ten days after you comply with the above conditions, Owner will return to you one fully executed counterpart of the Contract Documents.

\_\_\_\_\_  
Owner  
By: \_\_\_\_\_  
Authorized Signature  
\_\_\_\_\_  
Title

Copy to Engineer

**AGREEMENT  
BETWEEN OWNER AND CONTRACTOR FOR  
CONSTRUCTION CONTRACT (STIPULATED PRICE)**

Prepared by

**ENGINEERS JOINT CONTRACT DOCUMENTS COMMITTEE**

and

Issued and Published Jointly by



AMERICAN COUNCIL OF ENGINEERING COMPANIES

ASSOCIATED GENERAL CONTRACTORS OF AMERICA

AMERICAN SOCIETY OF CIVIL ENGINEERS

PROFESSIONAL ENGINEERS IN PRIVATE PRACTICE  
*A Practice Division of the*  
NATIONAL SOCIETY OF PROFESSIONAL ENGINEERS

Endorsed by



CONSTRUCTION SPECIFICATIONS INSTITUTE

---

EJCDC C-520 Agreement Between Owner and Contractor for Construction Contract (Stipulated Price)  
Copyright © 2007 National Society of Professional Engineers for EJCDC. All rights reserved.

---

Copyright © 2007 National Society of Professional Engineers  
1420 King Street, Alexandria, VA 22314-2794  
(703) 684-2882  
[www.nspe.org](http://www.nspe.org)

American Council of Engineering Companies  
1015 15th Street N.W., Washington, DC 20005  
(202) 347-7474  
[www.acec.org](http://www.acec.org)

American Society of Civil Engineers  
1801 Alexander Bell Drive, Reston, VA 20191-4400  
(800) 548-2723  
[www.asce.org](http://www.asce.org)

Associated General Contractors of America  
2300 Wilson Boulevard, Suite 400, Arlington, VA 22201-3308  
(703) 548-3118  
[www.agc.org](http://www.agc.org)

The copyright for this EJCDC document is owned jointly by the four  
EJCDC sponsoring organizations and held in trust for their benefit by NSPE.

**AGREEMENT  
BETWEEN OWNER AND CONTRACTOR  
FOR CONSTRUCTION CONTRACT (STIPULATED PRICE)**

THIS AGREEMENT is by and between \_\_\_\_\_ City of Scottsbluff, Nebraska \_\_\_\_\_ (“Owner”) and  
\_\_\_\_\_  
\_\_\_\_\_ (“Contractor”).

Owner and Contractor hereby agree as follows:

**ARTICLE 1 – WORK**

1.01 Contractor shall complete all Work as specified or indicated in the Contract Documents. The Work is generally described as follows:

**Construction of 1,000 lineal feet of 8” PVC water line, 120 lineal feet of 6” PVC water line (fire hydrant laterals), two (2) 8” gate valves with valve boxes, two (2) new fire hydrants with auxiliary valve and valve box, removal and reset of one (1) existing fire hydrant with a new auxiliary valve and valve box, one (1) 3” service connection, two (2) 2” service connections, seven (7) 1” service connections, 30 lineal feet of 3” service line, 50 lineal feet of 2” service line, 280 lineal feet of 1” service line, various fittings, and associated improvements for the City of Scottsbluff.**

**ARTICLE 2 – THE PROJECT**

2.01 The Project for which the Work under the Contract Documents may be the whole or only a part is generally described as follows:

**Water District 105 – Block 2, Reganis Subdivision and Block 1A, Scotts Bluff County College Tract**

**ARTICLE 3 – ENGINEER**

3.01 The Project has been designed by M.C. Schaff & Associates, Inc. (Engineer), which is to act as Owner’s representative, assume all duties and responsibilities, and have the rights and authority assigned to Engineer in the Contract Documents in connection with the completion of the Work in accordance with the Contract Documents.

**ARTICLE 4 – CONTRACT TIMES**

4.01 *Time of the Essence*

A. All time limits for Milestones, if any, Substantial Completion, and completion and readiness for final payment as stated in the Contract Documents are of the essence of the Contract.



4.02 *Days to Achieve Substantial Completion and Final Payment*

A. The Work will be substantially completed within **30 calendar days** after the date when the Contract Times commence to run as provided in Paragraph 2.03 of the General Conditions, and completed and ready for final payment in accordance with Paragraph 14.07 of the General Conditions within **45 calendar days** after the date when the Contract Times commence to run.

4.03 *Liquidated Damages*

A. Contractor and Owner recognize that time is of the essence as stated in Paragraph 4.01 above and that Owner will suffer financial loss if the Work is not completed within the times specified in Paragraph 4.02 above, plus any extensions thereof allowed in accordance with Article 12 of the General Conditions. The parties also recognize the delays, expense, and difficulties involved in proving in a legal or arbitration proceeding the actual loss suffered by Owner if the Work is not completed on time. Accordingly, instead of requiring any such proof, Owner and Contractor agree that as liquidated damages for delay (but not as a penalty), Contractor shall pay Owner **\$300.00** for each day that expires after the time specified in Paragraph 4.02 above for Substantial Completion until the Work is substantially complete. After Substantial Completion, if Contractor shall neglect, refuse, or fail to complete the remaining Work within the Contract Time or any proper extension thereof granted by Owner, Contractor shall pay Owner **\$300.00** for each day that expires after the time specified in Paragraph 4.02 above for completion and readiness for final payment until the Work is completed and ready for final payment.

**ARTICLE 5 – CONTRACT PRICE**

5.01 Owner shall pay Contractor for completion of the Work in accordance with the Contract Documents an amount in current funds equal to the sum of the amounts determined pursuant to Paragraphs 5.01.A, 5.01.B, and 5.01.C below:

A. For all Work other than Unit Price Work, a lump sum of: **\$0.00**. All specific cash allowances are included in the above price in accordance with Paragraph 11.02 of the General Conditions.

B. For all Unit Price Work, an amount equal to the sum of the established unit price for each separately identified item of Unit Price Work times the actual quantity of that item:

<u>Item</u>	<u>Description</u>	<u>Estimated Quantity</u>	<u>Unit</u>	<u>Unit Price</u>	<u>Total Estimated Price</u>
1	Mobilization	1	LS	\$ _____	\$ _____
2	8" PVC Waterline	1,000	LF	\$ _____	\$ _____
3	6" PVC Waterline	120	LF	\$ _____	\$ _____

4	8" Water Valve and Valve Box	2	EA	\$ _____	\$ _____
5	Fire Hydrant w/ Auxiliary Valve & Valve Box	2	EA	\$ _____	\$ _____
6	Remove & Reset Fire Hydrant w/ New Auxiliary Valve & Valve Box	1	EA	\$ _____	\$ _____
7	3" Service Connection	1	EA	\$ _____	\$ _____
8	2" Service Connection	2	EA	\$ _____	\$ _____
9	1" Service Connection	7	EA	\$ _____	\$ _____
10	3" Service Line	30	LF	\$ _____	\$ _____
11	2" Service Line	50	LF	\$ _____	\$ _____
12	1" Service Line	280	LF	\$ _____	\$ _____
13	Fittings	1,800	LBS	\$ _____	\$ _____
14	Ball Locator	30	EA	\$ _____	\$ _____

**Total – Items 1 thru 14 = \$ \_\_\_\_\_**

The Bid prices for Unit Price Work set forth as of the Effective Date of the Agreement are based on estimated quantities. As provided in Paragraph 11.03 of the General Conditions, estimated quantities are not guaranteed, and determinations of actual quantities and classifications are to be made by Engineer as provided in Paragraph 9.07 of the General Conditions.

C. For all Work, at the prices stated in Contractor’s Bid, attached hereto as an exhibit.

**ARTICLE 6 – PAYMENT PROCEDURES**

**6.01 Submittal and Processing of Payments**

A. Contractor shall submit Applications for Payment in accordance with Article 14 of the General Conditions. Applications for Payment will be processed by Engineer as provided in the General Conditions.

**6.02 Progress Payments; Retainage**

A. Owner shall make progress payments on account of the Contract Price on the basis of Contractor’s Applications for Payment on or about the **25th** day of each month during performance of the Work as provided in Paragraph 6.02.A.1 below. All such payments will be measured by the schedule of values established as provided in Paragraph 2.07.A of the General Conditions (and in the case of Unit Price Work based on the number of

units completed) or, in the event there is no schedule of values, as provided in the General Requirements.

1. Prior to Substantial Completion, progress payments will be made in an amount equal to the percentage indicated below but, in each case, less the aggregate of payments previously made and less such amounts as Engineer may determine or Owner may withhold, including but not limited to liquidated damages, in accordance with Paragraph 14.02 of the General Conditions.
  - a. **95** percent of Work completed (with the balance being retainage). ~~If the Work has been 50 percent completed as determined by Engineer, and if the character and progress of the Work have been satisfactory to Owner and Engineer, then as long as the character and progress of the Work remain satisfactory to Owner and Engineer, there will be no additional retainage; and~~
  - b. **95** percent of cost of materials and equipment not incorporated in the Work (with the balance being retainage).
- B. Upon Substantial Completion, Owner shall pay an amount sufficient to increase total payments to Contractor to **95** percent of the Work completed, less such amounts as Engineer shall determine in accordance with Paragraph 14.02.B.5 of the General Conditions and less **200** percent of Engineer's estimate of the value of Work to be completed or corrected as shown on the tentative list of items to be completed or corrected attached to the certificate of Substantial Completion.

#### 6.03 *Final Payment*

- A. Upon final completion and acceptance of the Work in accordance with Paragraph 14.07 of the General Conditions, Owner shall pay the remainder of the Contract Price as recommended by Engineer as provided in said Paragraph 14.07.

### **ARTICLE 7 – INTEREST**

- 7.01 All moneys not paid when due as provided in Article 14 of the General Conditions shall bear interest at the rate of **5** percent per annum.

### **ARTICLE 8 – CONTRACTOR'S REPRESENTATIONS**

- 8.01 In order to induce Owner to enter into this Agreement, Contractor makes the following representations:
  - A. Contractor has examined and carefully studied the Contract Documents and the other related data identified in the Bidding Documents.
  - B. Contractor has visited the Site and become familiar with and is satisfied as to the general, local, and Site conditions that may affect cost, progress, and performance of the Work.
  - C. Contractor is familiar with and is satisfied as to all federal, state, and local Laws and Regulations that may affect cost, progress, and performance of the Work.

---

EJCDC C-520 Agreement Between Owner and Contractor for Construction Contract (Stipulated Price)  
Copyright © 2007 National Society of Professional Engineers for EJCDC. All rights reserved.

---

- D. Contractor has carefully studied all: (1) reports of explorations and tests of subsurface conditions at or contiguous to the Site and all drawings of physical conditions relating to existing surface or subsurface structures at the Site (except Underground Facilities), if any, that have been identified in Paragraph SC-4.02 of the Supplementary Conditions as containing reliable "technical data," and (2) reports and drawings of Hazardous Environmental Conditions, if any, at the Site that have been identified in Paragraph SC-4.06 of the Supplementary Conditions as containing reliable "technical data."
- E. Contractor has considered the information known to Contractor; information commonly known to contractors doing business in the locality of the Site; information and observations obtained from visits to the Site; the Contract Documents; and the Site-related reports and drawings identified in the Contract Documents, with respect to the effect of such information, observations, and documents on (1) the cost, progress, and performance of the Work; (2) the means, methods, techniques, sequences, and procedures of construction to be employed by Contractor, including any specific means, methods, techniques, sequences, and procedures of construction expressly required by the Contract Documents; and (3) Contractor's safety precautions and programs.
- F. Based on the information and observations referred to in Paragraph 8.01.E above, Contractor does not consider that further examinations, investigations, explorations, tests, studies, or data are necessary for the performance of the Work at the Contract Price, within the Contract Times, and in accordance with the other terms and conditions of the Contract Documents.
- G. Contractor is aware of the general nature of work to be performed by Owner and others at the Site that relates to the Work as indicated in the Contract Documents.
- H. Contractor has given Engineer written notice of all conflicts, errors, ambiguities, or discrepancies that Contractor has discovered in the Contract Documents, and the written resolution thereof by Engineer is acceptable to Contractor.
- I. The Contract Documents are generally sufficient to indicate and convey understanding of all terms and conditions for performance and furnishing of the Work.

## **ARTICLE 9 – CONTRACT DOCUMENTS**

### *9.01 Contents*

- A. The Contract Documents consist of the following:
  - 1. This Agreement (pages 1 to 11, inclusive).
  - 2. Performance bond (pages 1 to 3, inclusive).
  - 3. Payment bond (pages 1 to 3, inclusive).
  - 4. Other bonds (pages \_\_\_\_\_ to \_\_\_\_\_, inclusive).
  - 5. General Conditions (pages 1 to 62, inclusive).

---

EJCDC C-520 Agreement Between Owner and Contractor for Construction Contract (Stipulated Price)  
Copyright © 2007 National Society of Professional Engineers for EJCDC. All rights reserved.

---

6. Supplementary Conditions (pages   1   to   7  , inclusive).
  7. Specifications as listed in the table of contents of the Project Manual.
  8. Addenda (numbers N/A ).
  9. Exhibits to this Agreement (enumerated as follows):
    - a. Contractor's Bid (pages   1   to   6  , inclusive).
    - b. Documentation submitted by Contractor prior to Notice of Award (pages \_\_\_\_\_ to \_\_\_\_\_, inclusive).
    - c. *[List other required attachments (if any), such as documents required by funding or lending agencies].*
  10. The following which may be delivered or issued on or after the Effective Date of the Agreement and are not attached hereto:
    - a. Notice to Proceed (pages   1   ).
    - b. Work Change Directives.
    - c. Change Orders.
- B. The documents listed in Paragraph 9.01.A are attached to this Agreement (except as expressly noted otherwise above).
- C. There are no Contract Documents other than those listed above in this Article 9.
- D. The Contract Documents may only be amended, modified, or supplemented as provided in Paragraph 3.04 of the General Conditions.

## **ARTICLE 10 – MISCELLANEOUS**

### 10.01 *Terms*

- A. Terms used in this Agreement will have the meanings stated in the General Conditions and the Supplementary Conditions.

### 10.02 *Assignment of Contract*

- A. No assignment by a party hereto of any rights under or interests in the Contract will be binding on another party hereto without the written consent of the party sought to be bound; and, specifically but without limitation, moneys that may become due and moneys that are due may not be assigned without such consent (except to the extent that the effect of this restriction may be limited by law), and unless specifically stated to the contrary in any written consent to an assignment, no assignment will release or discharge the assignor from any duty or responsibility under the Contract Documents.

10.03 *Successors and Assigns*

- A. Owner and Contractor each binds itself, its partners, successors, assigns, and legal representatives to the other party hereto, its partners, successors, assigns, and legal representatives in respect to all covenants, agreements, and obligations contained in the Contract Documents.

10.04 *Severability*

- A. Any provision or part of the Contract Documents held to be void or unenforceable under any Law or Regulation shall be deemed stricken, and all remaining provisions shall continue to be valid and binding upon Owner and Contractor, who agree that the Contract Documents shall be reformed to replace such stricken provision or part thereof with a valid and enforceable provision that comes as close as possible to expressing the intention of the stricken provision.

10.05 *Contractor's Certifications*

- A. Contractor certifies that it has not engaged in corrupt, fraudulent, collusive, or coercive practices in competing for or in executing the Contract. For the purposes of this Paragraph 10.05:
  - 1. "corrupt practice" means the offering, giving, receiving, or soliciting of any thing of value likely to influence the action of a public official in the bidding process or in the Contract execution;
  - 2. "fraudulent practice" means an intentional misrepresentation of facts made (a) to influence the bidding process or the execution of the Contract to the detriment of Owner, (b) to establish Bid or Contract prices at artificial non-competitive levels, or (c) to deprive Owner of the benefits of free and open competition;
  - 3. "collusive practice" means a scheme or arrangement between two or more Bidders, with or without the knowledge of Owner, a purpose of which is to establish Bid prices at artificial, non-competitive levels; and
  - 4. "coercive practice" means harming or threatening to harm, directly or indirectly, persons or their property to influence their participation in the bidding process or affect the execution of the Contract.

10.06 *Other Provisions*

- A. None**

IN WITNESS WHEREOF, Owner and Contractor have signed this Agreement. Counterparts have been delivered to Owner and Contractor. All portions of the Contract Documents have been signed or have been identified by Owner and Contractor or on their behalf.

This Agreement will be effective on \_\_\_\_\_, 20\_\_ (which is the Effective Date of the Agreement).

OWNER:

CONTRACTOR

City of Scottsbluff \_\_\_\_\_

\_\_\_\_\_

By: \_\_\_\_\_

By: \_\_\_\_\_

Title: Mayor \_\_\_\_\_

Title: \_\_\_\_\_

(If Contractor is a corporation, a partnership, or a joint venture, attach evidence of authority to sign.)

Attest: \_\_\_\_\_

Attest: \_\_\_\_\_

Title: \_\_\_\_\_

Title: \_\_\_\_\_

Address for giving notices:

Address for giving notices:

City of Scottsbluff \_\_\_\_\_

\_\_\_\_\_

2525 Circle Drive \_\_\_\_\_

\_\_\_\_\_

Scottsbluff, NE 69361 \_\_\_\_\_

\_\_\_\_\_

\_\_\_\_\_

\_\_\_\_\_

License No.: \_\_\_\_\_

(Where applicable)

(If Owner is a corporation, attach evidence of authority to sign. If Owner is a public body, attach evidence of authority to sign and resolution or other documents authorizing execution of this Agreement.)

*NOTE TO USER: Use in those states or other jurisdictions where applicable or required.*

Agent for service of process:

\_\_\_\_\_

# Notice to Proceed

Date: \_\_\_\_\_

Project: Water District 105 – Scottsbluff, NE

Owner: City of Scottsbluff, Nebraska

Owner's Contract No.:

Contract:

Engineer's Project No.: RM140169-00

Contractor:

Contractor's Address:

You are notified that the Contract Times under the above Contract will commence to run on \_\_\_\_\_. On or before that date, you are to start performing your obligations under the Contract Documents. In accordance with Article 4 of the Agreement, the date of Substantial Completion is \_\_\_\_\_, and the date of readiness for final payment is [(or) the number of days to achieve Substantial Completion is 30 calendar days, and the number of days to achieve readiness for final payment is 45 calendar days.

Before you may start any Work at the Site, Paragraph 2.01.B of the General Conditions provides that you and Owner must each deliver to the other (with copies to Engineer and other identified additional insureds and loss payees) certificates of insurance which each is required to purchase and maintain in accordance with the Contract Documents.

Also, before you may start any Work at the Site, you must: **Notify the Engineer**

\_\_\_\_\_

Engineer

Given by:

\_\_\_\_\_

Authorized Signature

\_\_\_\_\_

Title

\_\_\_\_\_

Date

Copy to City

EJCDC C-550 Notice to Proceed  
Prepared by the Engineers Joint Contract Documents Committee and endorsed by the Construction Specifications Institute.

Page 1 of 1



**PERFORMANCE BOND**

Any singular reference to Contractor, Surety, Owner, or other party shall be considered plural where applicable.

CONTRACTOR (*Name and Address*): SURETY (*Name, and Address of Principal Place of Business*):

OWNER (*Name and Address*):

City of Scottsbluff  
2525 Circle Drive  
Scottsbluff, NE 69361

**CONTRACT**

Effective Date of Agreement:  
Amount:  
Description (*Name and Location*): Water District 105- Scottsbluff, NE

**BOND**

Bond Number:  
Date (*Not earlier than Effective Date of Agreement*):  
Amount:  
Modifications to this Bond Form:

Surety and Contractor, intending to be legally bound hereby, subject to the terms set forth below, do each cause this Performance Bond to be duly executed by an authorized officer, agent, or representative.

**CONTRACTOR AS PRINCIPAL**

**SURETY**

\_\_\_\_\_  
Contractor's Name and Corporate Seal (Seal)

\_\_\_\_\_  
Surety's Name and Corporate Seal (Seal)

By: \_\_\_\_\_  
Signature  
  
\_\_\_\_\_  
Print Name  
  
\_\_\_\_\_  
Title

By: \_\_\_\_\_  
Signature (Attach Power of Attorney)  
  
\_\_\_\_\_  
Print Name  
  
\_\_\_\_\_  
Title

Attest: \_\_\_\_\_  
Signature  
  
\_\_\_\_\_  
Title

Attest: \_\_\_\_\_  
Signature  
  
\_\_\_\_\_  
Title

*Note: Provide execution by additional parties, such as joint venturers, if necessary.*

Contractor and Surety, jointly and severally, bind themselves, their heirs, executors, administrators, successors, and assigns to Owner for the performance of the Contract, which is incorporated herein by reference.

1. If Contractor performs the Contract, Surety and Contractor have no obligation under this Bond, except to participate in conferences as provided in Paragraph 2.1.
2. If there is no Owner Default, Surety's obligation under this Bond shall arise after:
  - 2.1 Owner has notified Contractor and Surety, at the addresses described in Paragraph 9 below, that Owner is considering declaring a Contractor Default and has requested and attempted to arrange a conference with Contractor and Surety to be held not later than 15 days after receipt of such notice to discuss methods of performing the Contract. If Owner, Contractor, and Surety agree, Contractor shall be allowed a reasonable time to perform the Contract, but such an agreement shall not waive Owner's right, if any, subsequently to declare a Contractor Default; and
  - 2.2 Owner has declared a Contractor Default and formally terminated Contractor's right to complete the Contract. Such Contractor Default shall not be declared earlier than 20 days after Contractor and Surety have received notice as provided in Paragraph 2.1; and
  - 2.3 Owner has agreed to pay the Balance of the Contract Price to:
    1. Surety in accordance with the terms of the Contract; or
    2. Another contractor selected pursuant to Paragraph 3.3 to perform the Contract.
3. When Owner has satisfied the conditions of Paragraph 2, Surety shall promptly, and at Surety's expense, take one of the following actions:
  - 3.1 Arrange for Contractor, with consent of Owner, to perform and complete the Contract; or
  - 3.2 Undertake to perform and complete the Contract itself, through its agents or through independent contractors; or
  - 3.3 Obtain bids or negotiated proposals from qualified contractors acceptable to Owner for a contract for performance and completion of the Contract, arrange for a contract to be prepared for execution by Owner and contractor selected with Owner's concurrence, to be secured with performance and payment bonds executed by a qualified surety equivalent to the bonds issued on the Contract, and pay to Owner the amount of damages as described in Paragraph 5 in excess of the Balance of the Contract Price incurred by Owner resulting from Contractor Default; or
  - 3.4 Waive its right to perform and complete, arrange for completion, or obtain a new contractor, and with reasonable promptness under the circumstances:
    1. After investigation, determine the amount for which it may be liable to Owner and, as soon as practicable after the amount is determined, tender payment therefor to Owner; or
    2. Deny liability in whole or in part and notify Owner citing reasons therefor.
4. If Surety does not proceed as provided in Paragraph 3 with reasonable promptness, Surety shall be deemed to be in default on this Bond 15 days after receipt of an additional written notice from Owner to Surety demanding that Surety perform its obligations under this Bond, and Owner shall be entitled to enforce any remedy available to Owner. If Surety proceeds as provided in Paragraph 3.4, and Owner refuses the payment tendered or Surety has denied liability, in whole or in part, without further notice Owner shall be entitled to enforce any remedy available to Owner.
5. After Owner has terminated Contractor's right to complete the Contract, and if Surety elects to act under Paragraph 3.1, 3.2, or 3.3 above, then the responsibilities of Surety to Owner shall not be greater than those of Contractor under the Contract, and the responsibilities of Owner to Surety shall not be greater than those of Owner under the Contract. To the limit of the amount of this Bond, but subject to commitment by Owner of the Balance of the Contract Price to mitigation of costs and damages on the Contract, Surety is obligated without duplication for:

- 5.1 The responsibilities of Contractor for correction of defective Work and completion of the Contract;
- 5.2 Additional legal, design professional, and delay costs resulting from Contractor's Default, and resulting from the actions of or failure to act of Surety under Paragraph 3; and
- 5.3 Liquidated damages, or if no liquidated damages are specified in the Contract, actual damages caused by delayed performance or non-performance of Contractor.

6. Surety shall not be liable to Owner or others for obligations of Contractor that are unrelated to the Contract, and the Balance of the Contract Price shall not be reduced or set off on account of any such unrelated obligations. No right of action shall accrue on this Bond to any person or entity other than Owner or its heirs, executors, administrators, or successors.

7. Surety hereby waives notice of any change, including changes of time, to Contract or to related subcontracts, purchase orders, and other obligations.

8. Any proceeding, legal or equitable, under this Bond may be instituted in any court of competent jurisdiction in the location in which the Work or part of the Work is located, and shall be instituted within two years after Contractor Default or within two years after Contractor ceased working or within two years after Surety refuses or fails to perform its obligations under this Bond, whichever occurs first. If the provisions of this paragraph are void or prohibited by law, the minimum period of limitation available to sureties as a defense in the jurisdiction of the suit shall be applicable.

9. Notice to Surety, Owner, or Contractor shall be mailed or delivered to the address shown on the signature page.

10. When this Bond has been furnished to comply with a statutory requirement in the location where the Contract was to be performed, any provision in this Bond conflicting with said statutory requirement shall be deemed deleted herefrom and provisions conforming to such statutory requirement shall be deemed incorporated herein. The intent is that this Bond shall be construed as a statutory bond and not as a common law bond.

11. Definitions.

11.1 Balance of the Contract Price: The total amount payable by Owner to Contractor under the Contract after all proper adjustments have been made, including allowance to Contractor of any amounts received or to be received by Owner in settlement of insurance or other Claims for damages to which Contractor is entitled, reduced by all valid and proper payments made to or on behalf of Contractor under the Contract.

11.2 Contract: The agreement between Owner and Contractor identified on the signature page, including all Contract Documents and changes thereto.

11.3 Contractor Default: Failure of Contractor, which has neither been remedied nor waived, to perform or otherwise to comply with the terms of the Contract.

11.4 Owner Default: Failure of Owner, which has neither been remedied nor waived, to pay Contractor as required by the Contract or to perform and complete or otherwise comply with the other terms thereof.

FOR INFORMATION ONLY – *(Name, Address and Telephone)*

Surety Agency or Broker:

Owner's Representative *(Engineer or other party)*:

**PAYMENT BOND**

Any singular reference to Contractor, Surety, Owner, or other party shall be considered plural where applicable.

CONTRACTOR (*Name and Address*):

SURETY (*Name, and Address of Principal Place of Business*):

OWNER (*Name and Address*):

City of Scottsbluff  
2525 Circle Drive  
Scottsbluff, NE 69361

CONTRACT

Effective Date of Agreement:  
Amount:  
Description (*Name and Location*): Water District 105- Scottsbluff, NE

BOND

Bond Number:  
Date (*Not earlier than Effective Date of Agreement*):  
Amount:  
Modifications to this Bond Form:

Surety and Contractor, intending to be legally bound hereby, subject to the terms set forth below, do each cause this Payment Bond to be duly executed by an authorized officer, agent, or representative.

**CONTRACTOR AS PRINCIPAL**

**SURETY**

\_\_\_\_\_  
(Seal)  
Contractor's Name and Corporate Seal

\_\_\_\_\_  
(Seal)  
Surety's Name and Corporate Seal

By: \_\_\_\_\_  
Signature

By: \_\_\_\_\_  
Signature (Attach Power of Attorney)

\_\_\_\_\_  
Print Name

\_\_\_\_\_  
Print Name

\_\_\_\_\_  
Title

\_\_\_\_\_  
Title

Attest: \_\_\_\_\_  
Signature

Attest: \_\_\_\_\_  
Signature

\_\_\_\_\_  
Title

\_\_\_\_\_  
Title

*Note: Provide execution by additional parties, such as joint venturers, if necessary.*

1. Contractor and Surety, jointly and severally, bind themselves, their heirs, executors, administrators, successors, and assigns to Owner to pay for labor, materials, and equipment furnished by Claimants for use in the performance of the Contract, which is incorporated herein by reference.
2. With respect to Owner, this obligation shall be null and void if Contractor:
  - 2.1 Promptly makes payment, directly or indirectly, for all sums due Claimants, and
  - 2.2 Defends, indemnifies, and holds harmless Owner from all claims, demands, liens, or suits alleging non-payment by Contractor by any person or entity who furnished labor, materials, or equipment for use in the performance of the Contract, provided Owner has promptly notified Contractor and Surety (at the addresses described in Paragraph 12) of any claims, demands, liens, or suits and tendered defense of such claims, demands, liens, or suits to Contractor and Surety, and provided there is no Owner Default.
3. With respect to Claimants, this obligation shall be null and void if Contractor promptly makes payment, directly or indirectly, for all sums due.
4. Surety shall have no obligation to Claimants under this Bond until:
  - 4.1 Claimants who are employed by or have a direct contract with Contractor have given notice to Surety (at the address described in Paragraph 12) and sent a copy, or notice thereof, to Owner, stating that a claim is being made under this Bond and, with substantial accuracy, the amount of the claim.
  - 4.2 Claimants who do not have a direct contract with Contractor:
    1. Have furnished written notice to Contractor and sent a copy, or notice thereof, to Owner, within 90 days after having last performed labor or last furnished materials or equipment included in the claim stating, with substantial accuracy, the amount of the claim and the name of the party to whom the materials or equipment were furnished or supplied, or for whom the labor was done or performed; and
    2. Have either received a rejection in whole or in part from Contractor, or not received within 30 days of furnishing the above notice any communication from Contractor by which Contractor had indicated the claim will be paid directly or indirectly; and
    3. Not having been paid within the above 30 days, have sent a written notice to Surety (at the address described in Paragraph 12) and sent a copy, or notice thereof, to Owner, stating that a claim is being made under this Bond and enclosing a copy of the previous written notice furnished to Contractor.
5. If a notice by a Claimant required by Paragraph 4 is provided by Owner to Contractor or to Surety, that is sufficient compliance.
6. Reserved.
7. Surety's total obligation shall not exceed the amount of this Bond, and the amount of this Bond shall be credited for any payments made in good faith by Surety.
8. Amounts owed by Owner to Contractor under the Contract shall be used for the performance of the Contract and to satisfy claims, if any, under any performance bond. By Contractor furnishing and Owner accepting this Bond, they agree that all funds earned by Contractor in the performance of the Contract are dedicated to satisfy obligations of Contractor and Surety under this Bond, subject to Owner's priority to use the funds for the completion of the Work.
9. Surety shall not be liable to Owner, Claimants, or others for obligations of Contractor that are unrelated to the Contract. Owner shall not be liable for payment of any costs or expenses of any Claimant under this Bond, and shall have under this Bond no obligations to make payments to, give notices on behalf of, or otherwise have obligations to Claimants under this Bond.

10. Surety hereby waives notice of any change, including changes of time, to the Contract or to related subcontracts, purchase orders, and other obligations.

11. No suit or action shall be commenced by a Claimant under this Bond other than in a court of competent jurisdiction in the location in which the Work or part of the Work is located or after the expiration of one year from the date (1) on which the Claimant gave the notice required by Paragraph 4.1 or Paragraph 4.2.3, or (2) on which the last labor or service was performed by anyone or the last materials or equipment were furnished by anyone under the Contract, whichever of (1) or (2) first occurs. If the provisions of this paragraph are void or prohibited by law, the minimum period of limitation available to sureties as a defense in the jurisdiction of the suit shall be applicable.

12. Notice to Surety, Owner, or Contractor shall be mailed or delivered to the addresses shown on the signature page. Actual receipt of notice by Surety, Owner, or Contractor, however accomplished, shall be sufficient compliance as of the date received at the address shown on the signature page.

13. When this Bond has been furnished to comply with a statutory requirement in the location where the Contract was to be performed, any provision in this Bond conflicting with said statutory requirement shall be deemed deleted herefrom and provisions conforming to such statutory requirement shall be deemed incorporated herein. The intent is that this Bond shall be construed as a statutory Bond and not as a common law bond.

14. Upon request of any person or entity appearing to be a potential beneficiary of this Bond, Contractor shall promptly furnish a copy of this Bond or shall permit a copy to be made.

15. Definitions

15.1 Claimant: An individual or entity having a direct contract with Contractor, or with a first-tier subcontractor of Contractor, to furnish labor, materials, or equipment for use in the performance of the Contract. The intent of this Bond shall be to include without limitation in the terms "labor, materials or equipment" that part of water, gas, power, light, heat, oil, gasoline, telephone service, or rental equipment used in the Contract, architectural and engineering services required for performance of the Work of Contractor and Contractor's subcontractors, and all other items for which a mechanic's lien may be asserted in the jurisdiction where the labor, materials, or equipment were furnished.

15.2 Contract: The agreement between Owner and Contractor identified on the signature page, including all Contract Documents and changes thereto.

15.3 Owner Default: Failure of Owner, which has neither been remedied nor waived, to pay Contractor as required by the Contract, or to perform and complete or otherwise comply with the other terms thereof.

FOR INFORMATION ONLY – *(Name, Address, and Telephone)*

Surety Agency or Broker:

Owner's Representative (*Engineer or other*): M.C. Schaff & Associates

## Contractor's Application for Payment No.

	Application Period:	Application Date:
To (Owner):	From (Contractor):	Via (Engineer): M.C. Schaff and Associates
Project:	Contract:	
Owner's Contract No.:	Contractor's Project No.:	Engineer's Project No.: RM140169-00

### Application For Payment Change Order Summary

Approved Change Orders			
Number	Additions	Deductions	
TOTALS			
NET CHANGE BY CHANGE ORDERS			

	1. ORIGINAL CONTRACT PRICE..... \$ _____
	2. Net change by Change Orders..... \$ _____
	3. Current Contract Price (Line 1 ± 2)..... \$ _____
	4. TOTAL COMPLETED AND STORED TO DATE (Column F on Progress Estimate)..... \$ <u>#REF!</u>
	5. RETAINAGE:
	a. X <u>#REF!</u> Work Completed..... \$ <u>#REF!</u>
	b. X <u>#REF!</u> Stored Material..... \$ <u>#REF!</u>
	c. Total Retainage (Line 5a + Line 5b)..... \$ <u>#REF!</u>
	6. AMOUNT ELIGIBLE TO DATE (Line 4 - Line 5c)..... \$ <u>#REF!</u>
	7. LESS PREVIOUS PAYMENTS (Line 6 from prior Application)..... \$ _____
	8. AMOUNT DUE THIS APPLICATION..... \$ <u>#REF!</u>
	9. BALANCE TO FINISH, PLUS RETAINAGE (Column G on Progress Estimate + Line 5 above)..... \$ <u>#REF!</u>

**Contractor's Certification**  
 The undersigned Contractor certifies that to the best of its knowledge: (1) all previous progress payments received from Owner on account of Work done under the Contract have been applied on account to discharge Contractor's legitimate obligations incurred in connection with Work covered by prior Applications for Payment; (2) title of all Work, materials and equipment incorporated in said Work or otherwise listed in or covered by this Application for Payment will pass to Owner at time of payment free and clear of all Liens, security interests and encumbrances (except such as are covered by a Bond acceptable to Owner indemnifying Owner against any such Liens, security interest or encumbrances); and (3) all Work covered by this Application for Payment is in accordance with the Contract Documents and is not defective.

By:	Date:
-----	-------

Payment of: \$ \_\_\_\_\_  
 (Line 8 or other - attach explanation of the other amount)

is recommended by: \_\_\_\_\_ (Date)  
 (Engineer)

Payment of: \$ \_\_\_\_\_  
 (Line 8 or other - attach explanation of the other amount)

is approved by: \_\_\_\_\_ (Date)  
 (Owner)

Approved by: \_\_\_\_\_ (Date)  
 Funding Agency (if applicable)

**Progress Estimate**

**Contractor's Application**

For (contract):							Application Number:			
Application Period:							Application Date:			
A				B	C	D	E	F		
Item		Bid Quantity	Unit Price	Bid Value	RM140169-00	Value	Materials Presently Stored (not in C)	Total Completed and Stored to Date (D + E)	% (F) B	Balance to Finish (B - F)
Bid Item No.	Description									
<b>Totals</b>										



# Stored Material Summary

# Contractor's Application

For (contract):						Application Number:			
Application Period:						Application Date:			
A	B	C	D		E	F		G	
Invoice No.	Shop Drawing Transmittal No.	Materials Description	Stored Previously		Stored this Month		Incorporated in Work		Materials Remaining in Storage (\$) (D + E - F)
			Date (Month/Year)	Amount (\$)	RM140169-00	Subtotal	Date (Month/Year)	Amount (\$)	
<b>Totals</b>									

# Certificate of Substantial Completion

Project: Water District 105- Scottsbluff, NE

Owner: City of Scottsbluff, Nebraska

Owner's Contract No.:

Contract:

Engineer's Project No.: RM140169-00

**This [tentative] [definitive] Certificate of Substantial Completion applies to:**

- All Work under the Contract Documents:       The following specified portions of the Work:

---

---

---

---

\_\_\_\_\_  
Date of Substantial Completion

The Work to which this Certificate applies has been inspected by authorized representatives of Owner, Contractor, and Engineer, and found to be substantially complete. The Date of Substantial Completion of the Project or portion thereof designated above is hereby declared and is also the date of commencement of applicable warranties required by the Contract Documents, except as stated below.

A [tentative] [definitive] list of items to be completed or corrected is attached hereto. This list may not be all-inclusive, and the failure to include any items on such list does not alter the responsibility of the Contractor to complete all Work in accordance with the Contract Documents.

**The responsibilities between Owner and Contractor for security, operation, safety, maintenance, heat, utilities, insurance and warranties shall be as provided in the Contract Documents except as amended as follows:**

- Amended Responsibilities       Not Amended

Owner's Amended Responsibilities:

---

---

---

Contractor's Amended Responsibilities:

---

---

---

---

EJCDC C-625 Certificate of Substantial Completion  
Prepared by the Engineers Joint Contract Documents Committee and endorsed by the Construction Specifications Institute.

Page 1 of 2

The following documents are attached to and made part of this Certificate:

---

---

---

This Certificate does not constitute an acceptance of Work not in accordance with the Contract Documents nor is it a release of Contractor's obligation to complete the Work in accordance with the Contract Documents.

---

Executed by Engineer

---

Date

---

Accepted by Contractor

---

Date

---

Accepted by Owner

---

Date

# STANDARD GENERAL CONDITIONS OF THE CONSTRUCTION CONTRACT

Prepared by

**ENGINEERS JOINT CONTRACT DOCUMENTS COMMITTEE**

and

Issued and Published Jointly by



AMERICAN COUNCIL OF ENGINEERING COMPANIES

ASSOCIATED GENERAL CONTRACTORS OF AMERICA

AMERICAN SOCIETY OF CIVIL ENGINEERS

PROFESSIONAL ENGINEERS IN PRIVATE PRACTICE  
*A Practice Division of the*  
NATIONAL SOCIETY OF PROFESSIONAL ENGINEERS

Endorsed by



CONSTRUCTION SPECIFICATIONS INSTITUTE

---

EJCDC C-700 Standard General Conditions of the Construction Contract  
Copyright © 2007 National Society of Professional Engineers for EJCDC. All rights reserved.

---

Copyright © 2007 National Society of Professional Engineers  
1420 King Street, Alexandria, VA 22314-2794  
(703) 684-2882  
[www.nspe.org](http://www.nspe.org)

American Council of Engineering Companies  
1015 15th Street N.W., Washington, DC 20005  
(202) 347-7474  
[www.acec.org](http://www.acec.org)

American Society of Civil Engineers  
1801 Alexander Bell Drive, Reston, VA 20191-4400  
(800) 548-2723  
[www.asce.org](http://www.asce.org)

Associated General Contractors of America  
2300 Wilson Boulevard, Suite 400, Arlington, VA 22201-3308  
(703) 548-3118  
[www.agc.org](http://www.agc.org)

The copyright for this EJCDC document is owned jointly by the four EJCDC sponsoring organizations and held in trust for their benefit by NSPE.

# STANDARD GENERAL CONDITIONS OF THE CONSTRUCTION CONTRACT

## TABLE OF CONTENTS

	<b>Page</b>
Article 1 – Definitions and Terminology .....	1
1.01 Defined Terms.....	1
1.02 Terminology.....	5
Article 2 – Preliminary Matters.....	6
2.01 Delivery of Bonds and Evidence of Insurance.....	6
2.02 Copies of Documents.....	6
2.03 Commencement of Contract Times; Notice to Proceed .....	6
2.04 Starting the Work.....	7
2.05 Before Starting Construction .....	7
2.06 Preconstruction Conference; Designation of Authorized Representatives .....	7
2.07 Initial Acceptance of Schedules .....	7
Article 3 – Contract Documents: Intent, Amending, Reuse.....	8
3.01 Intent.....	8
3.02 Reference Standards .....	8
3.03 Reporting and Resolving Discrepancies .....	8
3.04 Amending and Supplementing Contract Documents .....	9
3.05 Reuse of Documents .....	10
3.06 Electronic Data.....	10
Article 4 – Availability of Lands; Subsurface and Physical Conditions; Hazardous Environmental Conditions; Reference Points .....	10
4.01 Availability of Lands .....	10
4.02 Subsurface and Physical Conditions .....	11
4.03 Differing Subsurface or Physical Conditions.....	11
4.04 Underground Facilities .....	13
4.05 Reference Points .....	14
4.06 Hazardous Environmental Condition at Site.....	14
Article 5 – Bonds and Insurance .....	16
5.01 Performance, Payment, and Other Bonds .....	16
5.02 Licensed Sureties and Insurers .....	16
5.03 Certificates of Insurance .....	16
5.04 Contractor’s Insurance.....	17
5.05 Owner’s Liability Insurance .....	18
5.06 Property Insurance .....	18
5.07 Waiver of Rights .....	20
5.08 Receipt and Application of Insurance Proceeds .....	21
5.09 Acceptance of Bonds and Insurance; Option to Replace.....	21

5.10	Partial Utilization, Acknowledgment of Property Insurer .....	21
<b>Article 6 – Contractor’s Responsibilities .....</b>		
6.01	Supervision and Superintendence .....	22
6.02	Labor; Working Hours.....	22
6.03	Services, Materials, and Equipment .....	22
6.04	Progress Schedule .....	23
6.05	Substitutes and “Or-Equals” .....	23
6.06	Concerning Subcontractors, Suppliers, and Others .....	25
6.07	Patent Fees and Royalties .....	26
6.08	Permits.....	27
6.09	Laws and Regulations.....	27
6.10	Taxes .....	28
6.11	Use of Site and Other Areas .....	28
6.12	Record Documents.....	29
6.13	Safety and Protection .....	29
6.14	Safety Representative .....	30
6.15	Hazard Communication Programs .....	30
6.16	Emergencies .....	30
6.17	Shop Drawings and Samples .....	30
6.18	Continuing the Work .....	32
6.19	Contractor’s General Warranty and Guarantee.....	32
6.20	Indemnification .....	33
6.21	Delegation of Professional Design Services .....	34
<b>Article 7 – Other Work at the Site.....</b>		
7.01	Related Work at Site .....	34
7.02	Coordination.....	35
7.03	Legal Relationships.....	35
<b>Article 8 – Owner’s Responsibilities .....</b>		
8.01	Communications to Contractor.....	36
8.02	Replacement of Engineer.....	36
8.03	Furnish Data .....	36
8.04	Pay When Due .....	36
8.05	Lands and Easements; Reports and Tests .....	36
8.06	Insurance .....	36
8.07	Change Orders.....	36
8.08	Inspections, Tests, and Approvals .....	36
8.09	Limitations on Owner’s Responsibilities .....	36
8.10	Undisclosed Hazardous Environmental Condition.....	37
8.11	Evidence of Financial Arrangements .....	37
8.12	Compliance with Safety Program.....	37
<b>Article 9 – Engineer’s Status During Construction .....</b>		
9.01	Owner’s Representative.....	37
9.02	Visits to Site .....	37
9.03	Project Representative .....	38

9.04	Authorized Variations in Work .....	38
9.05	Rejecting Defective Work .....	38
9.06	Shop Drawings, Change Orders and Payments .....	38
9.07	Determinations for Unit Price Work .....	38
9.08	Decisions on Requirements of Contract Documents and Acceptability of Work .....	39
9.09	Limitations on Engineer's Authority and Responsibilities.....	39
9.10	Compliance with Safety Program.....	40
Article 10 – Changes in the Work; Claims .....		40
10.01	Authorized Changes in the Work .....	40
10.02	Unauthorized Changes in the Work .....	40
10.03	Execution of Change Orders.....	40
10.04	Notification to Surety.....	41
10.05	Claims.....	41
Article 11 – Cost of the Work; Allowances; Unit Price Work.....		42
11.01	Cost of the Work.....	42
11.02	Allowances.....	44
11.03	Unit Price Work .....	45
Article 12 – Change of Contract Price; Change of Contract Times.....		45
12.01	Change of Contract Price.....	45
12.02	Change of Contract Times .....	47
12.03	Delays.....	47
Article 13 – Tests and Inspections; Correction, Removal or Acceptance of Defective Work.....		48
13.01	Notice of Defects .....	48
13.02	Access to Work .....	48
13.03	Tests and Inspections .....	48
13.04	Uncovering Work .....	49
13.05	Owner May Stop the Work.....	49
13.06	Correction or Removal of Defective Work.....	49
13.07	Correction Period.....	50
13.08	Acceptance of Defective Work .....	51
13.09	Owner May Correct Defective Work.....	51
Article 14 – Payments to Contractor and Completion.....		52
14.01	Schedule of Values .....	52
14.02	Progress Payments .....	52
14.03	Contractor's Warranty of Title .....	54
14.04	Substantial Completion.....	55
14.05	Partial Utilization .....	55
14.06	Final Inspection.....	56
14.07	Final Payment .....	56
14.08	Final Completion Delayed.....	57
14.09	Waiver of Claims .....	58



Article 15 – Suspension of Work and Termination .....	58
15.01 Owner May Suspend Work .....	58
15.02 Owner May Terminate for Cause .....	58
15.03 Owner May Terminate For Convenience.....	59
15.04 Contractor May Stop Work or Terminate .....	60
Article 16 – Dispute Resolution .....	60
16.01 Methods and Procedures.....	60
Article 17 – Miscellaneous .....	61
17.01 Giving Notice .....	61
17.02 Computation of Times .....	61
17.03 Cumulative Remedies .....	61
17.04 Survival of Obligations.....	61
17.05 Controlling Law .....	61
17.06 Headings.....	61

## ARTICLE 1 – DEFINITIONS AND TERMINOLOGY

### 1.01 *Defined Terms*

- A. Wherever used in the Bidding Requirements or Contract Documents and printed with initial capital letters, the terms listed below will have the meanings indicated which are applicable to both the singular and plural thereof. In addition to terms specifically defined, terms with initial capital letters in the Contract Documents include references to identified articles and paragraphs, and the titles of other documents or forms.
1. *Addenda*—Written or graphic instruments issued prior to the opening of Bids which clarify, correct, or change the Bidding Requirements or the proposed Contract Documents.
  2. *Agreement*—The written instrument which is evidence of the agreement between Owner and Contractor covering the Work.
  3. *Application for Payment*—The form acceptable to Engineer which is to be used by Contractor during the course of the Work in requesting progress or final payments and which is to be accompanied by such supporting documentation as is required by the Contract Documents.
  4. *Asbestos*—Any material that contains more than one percent asbestos and is friable or is releasing asbestos fibers into the air above current action levels established by the United States Occupational Safety and Health Administration.
  5. *Bid*—The offer or proposal of a Bidder submitted on the prescribed form setting forth the prices for the Work to be performed.
  6. *Bidder*—The individual or entity who submits a Bid directly to Owner.
  7. *Bidding Documents*—The Bidding Requirements and the proposed Contract Documents (including all Addenda).
  8. *Bidding Requirements*—The advertisement or invitation to bid, Instructions to Bidders, Bid security of acceptable form, if any, and the Bid Form with any supplements.
  9. *Change Order*—A document recommended by Engineer which is signed by Contractor and Owner and authorizes an addition, deletion, or revision in the Work or an adjustment in the Contract Price or the Contract Times, issued on or after the Effective Date of the Agreement.
  10. *Claim*—A demand or assertion by Owner or Contractor seeking an adjustment of Contract Price or Contract Times, or both, or other relief with respect to the terms of the Contract. A demand for money or services by a third party is not a Claim.
  11. *Contract*—The entire and integrated written agreement between the Owner and Contractor concerning the Work. The Contract supersedes prior negotiations, representations, or agreements, whether written or oral.

12. *Contract Documents*—Those items so designated in the Agreement. Only printed or hard copies of the items listed in the Agreement are Contract Documents. Approved Shop Drawings, other Contractor submittals, and the reports and drawings of subsurface and physical conditions are not Contract Documents.
13. *Contract Price*—The moneys payable by Owner to Contractor for completion of the Work in accordance with the Contract Documents as stated in the Agreement (subject to the provisions of Paragraph 11.03 in the case of Unit Price Work).
14. *Contract Times*—The number of days or the dates stated in the Agreement to: (i) achieve Milestones, if any; (ii) achieve Substantial Completion; and (iii) complete the Work so that it is ready for final payment as evidenced by Engineer's written recommendation of final payment.
15. *Contractor*—The individual or entity with whom Owner has entered into the Agreement.
16. *Cost of the Work*—See Paragraph 11.01 for definition.
17. *Drawings*—That part of the Contract Documents prepared or approved by Engineer which graphically shows the scope, extent, and character of the Work to be performed by Contractor. Shop Drawings and other Contractor submittals are not Drawings as so defined.
18. *Effective Date of the Agreement*—The date indicated in the Agreement on which it becomes effective, but if no such date is indicated, it means the date on which the Agreement is signed and delivered by the last of the two parties to sign and deliver.
19. *Engineer*—The individual or entity named as such in the Agreement.
20. *Field Order*—A written order issued by Engineer which requires minor changes in the Work but which does not involve a change in the Contract Price or the Contract Times.
21. *General Requirements*—Sections of Division 1 of the Specifications.
22. *Hazardous Environmental Condition*—The presence at the Site of Asbestos, PCBs, Petroleum, Hazardous Waste, or Radioactive Material in such quantities or circumstances that may present a substantial danger to persons or property exposed thereto.
23. *Hazardous Waste*—The term Hazardous Waste shall have the meaning provided in Section 1004 of the Solid Waste Disposal Act (42 USC Section 6903) as amended from time to time.
24. *Laws and Regulations; Laws or Regulations*—Any and all applicable laws, rules, regulations, ordinances, codes, and orders of any and all governmental bodies, agencies, authorities, and courts having jurisdiction.
25. *Liens*—Charges, security interests, or encumbrances upon Project funds, real property, or personal property.
26. *Milestone*—A principal event specified in the Contract Documents relating to an intermediate completion date or time prior to Substantial Completion of all the Work.

27. *Notice of Award*—The written notice by Owner to the Successful Bidder stating that upon timely compliance by the Successful Bidder with the conditions precedent listed therein, Owner will sign and deliver the Agreement.
28. *Notice to Proceed*—A written notice given by Owner to Contractor fixing the date on which the Contract Times will commence to run and on which Contractor shall start to perform the Work under the Contract Documents.
29. *Owner*—The individual or entity with whom Contractor has entered into the Agreement and for whom the Work is to be performed.
30. *PCBs*—Polychlorinated biphenyls.
31. *Petroleum*—Petroleum, including crude oil or any fraction thereof which is liquid at standard conditions of temperature and pressure (60 degrees Fahrenheit and 14.7 pounds per square inch absolute), such as oil, petroleum, fuel oil, oil sludge, oil refuse, gasoline, kerosene, and oil mixed with other non-Hazardous Waste and crude oils.
32. *Progress Schedule*—A schedule, prepared and maintained by Contractor, describing the sequence and duration of the activities comprising the Contractor's plan to accomplish the Work within the Contract Times.
33. *Project*—The total construction of which the Work to be performed under the Contract Documents may be the whole, or a part.
34. *Project Manual*—The bound documentary information prepared for bidding and constructing the Work. A listing of the contents of the Project Manual, which may be bound in one or more volumes, is contained in the table(s) of contents.
35. *Radioactive Material*—Source, special nuclear, or byproduct material as defined by the Atomic Energy Act of 1954 (42 USC Section 2011 et seq.) as amended from time to time.
36. *Resident Project Representative*—The authorized representative of Engineer who may be assigned to the Site or any part thereof.
37. *Samples*—Physical examples of materials, equipment, or workmanship that are representative of some portion of the Work and which establish the standards by which such portion of the Work will be judged.
38. *Schedule of Submittals*—A schedule, prepared and maintained by Contractor, of required submittals and the time requirements to support scheduled performance of related construction activities.
39. *Schedule of Values*—A schedule, prepared and maintained by Contractor, allocating portions of the Contract Price to various portions of the Work and used as the basis for reviewing Contractor's Applications for Payment.

40. *Shop Drawings*—All drawings, diagrams, illustrations, schedules, and other data or information which are specifically prepared or assembled by or for Contractor and submitted by Contractor to illustrate some portion of the Work.
41. *Site*—Lands or areas indicated in the Contract Documents as being furnished by Owner upon which the Work is to be performed, including rights-of-way and easements for access thereto, and such other lands furnished by Owner which are designated for the use of Contractor.
42. *Specifications*—That part of the Contract Documents consisting of written requirements for materials, equipment, systems, standards and workmanship as applied to the Work, and certain administrative requirements and procedural matters applicable thereto.
43. *Subcontractor*—An individual or entity having a direct contract with Contractor or with any other Subcontractor for the performance of a part of the Work at the Site.
44. *Substantial Completion*—The time at which the Work (or a specified part thereof) has progressed to the point where, in the opinion of Engineer, the Work (or a specified part thereof) is sufficiently complete, in accordance with the Contract Documents, so that the Work (or a specified part thereof) can be utilized for the purposes for which it is intended. The terms “substantially complete” and “substantially completed” as applied to all or part of the Work refer to Substantial Completion thereof.
45. *Successful Bidder*—The Bidder submitting a responsive Bid to whom Owner makes an award.
46. *Supplementary Conditions*—That part of the Contract Documents which amends or supplements these General Conditions.
47. *Supplier*—A manufacturer, fabricator, supplier, distributor, materialman, or vendor having a direct contract with Contractor or with any Subcontractor to furnish materials or equipment to be incorporated in the Work by Contractor or Subcontractor.
48. *Underground Facilities*—All underground pipelines, conduits, ducts, cables, wires, manholes, vaults, tanks, tunnels, or other such facilities or attachments, and any encasements containing such facilities, including those that convey electricity, gases, steam, liquid petroleum products, telephone or other communications, cable television, water, wastewater, storm water, other liquids or chemicals, or traffic or other control systems.
49. *Unit Price Work*—Work to be paid for on the basis of unit prices.
50. *Work*—The entire construction or the various separately identifiable parts thereof required to be provided under the Contract Documents. Work includes and is the result of performing or providing all labor, services, and documentation necessary to produce such construction, and furnishing, installing, and incorporating all materials and equipment into such construction, all as required by the Contract Documents.
51. *Work Change Directive*—A written statement to Contractor issued on or after the Effective Date of the Agreement and signed by Owner and recommended by Engineer ordering an

addition, deletion, or revision in the Work, or responding to differing or unforeseen subsurface or physical conditions under which the Work is to be performed or to emergencies. A Work Change Directive will not change the Contract Price or the Contract Times but is evidence that the parties expect that the change ordered or documented by a Work Change Directive will be incorporated in a subsequently issued Change Order following negotiations by the parties as to its effect, if any, on the Contract Price or Contract Times.

## 1.02 Terminology

A. The words and terms discussed in Paragraph 1.02.B through F are not defined but, when used in the Bidding Requirements or Contract Documents, have the indicated meaning.

### B. *Intent of Certain Terms or Adjectives:*

1. The Contract Documents include the terms “as allowed,” “as approved,” “as ordered,” “as directed” or terms of like effect or import to authorize an exercise of professional judgment by Engineer. In addition, the adjectives “reasonable,” “suitable,” “acceptable,” “proper,” “satisfactory,” or adjectives of like effect or import are used to describe an action or determination of Engineer as to the Work. It is intended that such exercise of professional judgment, action, or determination will be solely to evaluate, in general, the Work for compliance with the information in the Contract Documents and with the design concept of the Project as a functioning whole as shown or indicated in the Contract Documents (unless there is a specific statement indicating otherwise). The use of any such term or adjective is not intended to and shall not be effective to assign to Engineer any duty or authority to supervise or direct the performance of the Work, or any duty or authority to undertake responsibility contrary to the provisions of Paragraph 9.09 or any other provision of the Contract Documents.

### C. *Day:*

1. The word “day” means a calendar day of 24 hours measured from midnight to the next midnight.

### D. *Defective:*

1. The word “defective,” when modifying the word “Work,” refers to Work that is unsatisfactory, faulty, or deficient in that it:
  - a. does not conform to the Contract Documents; or
  - b. does not meet the requirements of any applicable inspection, reference standard, test, or approval referred to in the Contract Documents; or
  - c. has been damaged prior to Engineer’s recommendation of final payment (unless responsibility for the protection thereof has been assumed by Owner at Substantial Completion in accordance with Paragraph 14.04 or 14.05).

### E. *Furnish, Install, Perform, Provide:*

1. The word “furnish,” when used in connection with services, materials, or equipment, shall mean to supply and deliver said services, materials, or equipment to the Site (or some other specified location) ready for use or installation and in usable or operable condition.
  2. The word “install,” when used in connection with services, materials, or equipment, shall mean to put into use or place in final position said services, materials, or equipment complete and ready for intended use.
  3. The words “perform” or “provide,” when used in connection with services, materials, or equipment, shall mean to furnish and install said services, materials, or equipment complete and ready for intended use.
  4. When “furnish,” “install,” “perform,” or “provide” is not used in connection with services, materials, or equipment in a context clearly requiring an obligation of Contractor, “provide” is implied.
- F. Unless stated otherwise in the Contract Documents, words or phrases that have a well-known technical or construction industry or trade meaning are used in the Contract Documents in accordance with such recognized meaning.

## **ARTICLE 2 – PRELIMINARY MATTERS**

### *2.01 Delivery of Bonds and Evidence of Insurance*

- A. When Contractor delivers the executed counterparts of the Agreement to Owner, Contractor shall also deliver to Owner such bonds as Contractor may be required to furnish.
- B. *Evidence of Insurance:* Before any Work at the Site is started, Contractor and Owner shall each deliver to the other, with copies to each additional insured identified in the Supplementary Conditions, certificates of insurance (and other evidence of insurance which either of them or any additional insured may reasonably request) which Contractor and Owner respectively are required to purchase and maintain in accordance with Article 5.

### *2.02 Copies of Documents*

- A. Owner shall furnish to Contractor up to ten printed or hard copies of the Drawings and Project Manual. Additional copies will be furnished upon request at the cost of reproduction.

### *2.03 Commencement of Contract Times; Notice to Proceed*

- A. The Contract Times will commence to run on the thirtieth day after the Effective Date of the Agreement or, if a Notice to Proceed is given, on the day indicated in the Notice to Proceed. A Notice to Proceed may be given at any time within 30 days after the Effective Date of the Agreement. In no event will the Contract Times commence to run later than the sixtieth day after the day of Bid opening or the thirtieth day after the Effective Date of the Agreement, whichever date is earlier.

2.04 *Starting the Work*

- A. Contractor shall start to perform the Work on the date when the Contract Times commence to run. No Work shall be done at the Site prior to the date on which the Contract Times commence to run.

2.05 *Before Starting Construction*

- A. *Preliminary Schedules:* Within 10 days after the Effective Date of the Agreement (unless otherwise specified in the General Requirements), Contractor shall submit to Engineer for timely review:
  - 1. a preliminary Progress Schedule indicating the times (numbers of days or dates) for starting and completing the various stages of the Work, including any Milestones specified in the Contract Documents;
  - 2. a preliminary Schedule of Submittals; and
  - 3. a preliminary Schedule of Values for all of the Work which includes quantities and prices of items which when added together equal the Contract Price and subdivides the Work into component parts in sufficient detail to serve as the basis for progress payments during performance of the Work. Such prices will include an appropriate amount of overhead and profit applicable to each item of Work.

2.06 *Preconstruction Conference; Designation of Authorized Representatives*

- A. Before any Work at the Site is started, a conference attended by Owner, Contractor, Engineer, and others as appropriate will be held to establish a working understanding among the parties as to the Work and to discuss the schedules referred to in Paragraph 2.05.A, procedures for handling Shop Drawings and other submittals, processing Applications for Payment, and maintaining required records.
- B. At this conference Owner and Contractor each shall designate, in writing, a specific individual to act as its authorized representative with respect to the services and responsibilities under the Contract. Such individuals shall have the authority to transmit instructions, receive information, render decisions relative to the Contract, and otherwise act on behalf of each respective party.

2.07 *Initial Acceptance of Schedules*

- A. At least 10 days before submission of the first Application for Payment a conference attended by Contractor, Engineer, and others as appropriate will be held to review for acceptability to Engineer as provided below the schedules submitted in accordance with Paragraph 2.05.A. Contractor shall have an additional 10 days to make corrections and adjustments and to complete and resubmit the schedules. No progress payment shall be made to Contractor until acceptable schedules are submitted to Engineer.
  - 1. The Progress Schedule will be acceptable to Engineer if it provides an orderly progression of the Work to completion within the Contract Times. Such acceptance will not impose on Engineer responsibility for the Progress Schedule, for sequencing, scheduling, or progress of



the Work, nor interfere with or relieve Contractor from Contractor's full responsibility therefor.

2. Contractor's Schedule of Submittals will be acceptable to Engineer if it provides a workable arrangement for reviewing and processing the required submittals.
3. Contractor's Schedule of Values will be acceptable to Engineer as to form and substance if it provides a reasonable allocation of the Contract Price to component parts of the Work.

### **ARTICLE 3 – CONTRACT DOCUMENTS: INTENT, AMENDING, REUSE**

#### **3.01 *Intent***

- A. The Contract Documents are complementary; what is required by one is as binding as if required by all.
- B. It is the intent of the Contract Documents to describe a functionally complete project (or part thereof) to be constructed in accordance with the Contract Documents. Any labor, documentation, services, materials, or equipment that reasonably may be inferred from the Contract Documents or from prevailing custom or trade usage as being required to produce the indicated result will be provided whether or not specifically called for, at no additional cost to Owner.
- C. Clarifications and interpretations of the Contract Documents shall be issued by Engineer as provided in Article 9.

#### **3.02 *Reference Standards***

- A. Standards, Specifications, Codes, Laws, and Regulations
  1. Reference to standards, specifications, manuals, or codes of any technical society, organization, or association, or to Laws or Regulations, whether such reference be specific or by implication, shall mean the standard, specification, manual, code, or Laws or Regulations in effect at the time of opening of Bids (or on the Effective Date of the Agreement if there were no Bids), except as may be otherwise specifically stated in the Contract Documents.
  2. No provision of any such standard, specification, manual, or code, or any instruction of a Supplier, shall be effective to change the duties or responsibilities of Owner, Contractor, or Engineer, or any of their subcontractors, consultants, agents, or employees, from those set forth in the Contract Documents. No such provision or instruction shall be effective to assign to Owner, Engineer, or any of their officers, directors, members, partners, employees, agents, consultants, or subcontractors, any duty or authority to supervise or direct the performance of the Work or any duty or authority to undertake responsibility inconsistent with the provisions of the Contract Documents.

#### **3.03 *Reporting and Resolving Discrepancies***

- A. *Reporting Discrepancies:*

1. *Contractor's Review of Contract Documents Before Starting Work:* Before undertaking each part of the Work, Contractor shall carefully study and compare the Contract Documents and check and verify pertinent figures therein and all applicable field measurements. Contractor shall promptly report in writing to Engineer any conflict, error, ambiguity, or discrepancy which Contractor discovers, or has actual knowledge of, and shall obtain a written interpretation or clarification from Engineer before proceeding with any Work affected thereby.
2. *Contractor's Review of Contract Documents During Performance of Work:* If, during the performance of the Work, Contractor discovers any conflict, error, ambiguity, or discrepancy within the Contract Documents, or between the Contract Documents and (a) any applicable Law or Regulation, (b) any standard, specification, manual, or code, or (c) any instruction of any Supplier, then Contractor shall promptly report it to Engineer in writing. Contractor shall not proceed with the Work affected thereby (except in an emergency as required by Paragraph 6.16.A) until an amendment or supplement to the Contract Documents has been issued by one of the methods indicated in Paragraph 3.04.
3. Contractor shall not be liable to Owner or Engineer for failure to report any conflict, error, ambiguity, or discrepancy in the Contract Documents unless Contractor had actual knowledge thereof.

B. *Resolving Discrepancies:*

1. Except as may be otherwise specifically stated in the Contract Documents, the provisions of the Contract Documents shall take precedence in resolving any conflict, error, ambiguity, or discrepancy between the provisions of the Contract Documents and:
  - a. the provisions of any standard, specification, manual, or code, or the instruction of any Supplier (whether or not specifically incorporated by reference in the Contract Documents); or
  - b. the provisions of any Laws or Regulations applicable to the performance of the Work (unless such an interpretation of the provisions of the Contract Documents would result in violation of such Law or Regulation).

3.04 *Amending and Supplementing Contract Documents*

- A. The Contract Documents may be amended to provide for additions, deletions, and revisions in the Work or to modify the terms and conditions thereof by either a Change Order or a Work Change Directive.
- B. The requirements of the Contract Documents may be supplemented, and minor variations and deviations in the Work may be authorized, by one or more of the following ways:
  1. A Field Order;
  2. Engineer's approval of a Shop Drawing or Sample (subject to the provisions of Paragraph 6.17.D.3); or

3. Engineer's written interpretation or clarification.

### 3.05 *Reuse of Documents*

A. Contractor and any Subcontractor or Supplier shall not:

1. have or acquire any title to or ownership rights in any of the Drawings, Specifications, or other documents (or copies of any thereof) prepared by or bearing the seal of Engineer or its consultants, including electronic media editions; or
2. reuse any such Drawings, Specifications, other documents, or copies thereof on extensions of the Project or any other project without written consent of Owner and Engineer and specific written verification or adaptation by Engineer.

B. The prohibitions of this Paragraph 3.05 will survive final payment, or termination of the Contract. Nothing herein shall preclude Contractor from retaining copies of the Contract Documents for record purposes.

### 3.06 *Electronic Data*

A. Unless otherwise stated in the Supplementary Conditions, the data furnished by Owner or Engineer to Contractor, or by Contractor to Owner or Engineer, that may be relied upon are limited to the printed copies (also known as hard copies). Files in electronic media format of text, data, graphics, or other types are furnished only for the convenience of the receiving party. Any conclusion or information obtained or derived from such electronic files will be at the user's sole risk. If there is a discrepancy between the electronic files and the hard copies, the hard copies govern.

B. Because data stored in electronic media format can deteriorate or be modified inadvertently or otherwise without authorization of the data's creator, the party receiving electronic files agrees that it will perform acceptance tests or procedures within 60 days, after which the receiving party shall be deemed to have accepted the data thus transferred. Any errors detected within the 60-day acceptance period will be corrected by the transferring party.

C. When transferring documents in electronic media format, the transferring party makes no representations as to long term compatibility, usability, or readability of documents resulting from the use of software application packages, operating systems, or computer hardware differing from those used by the data's creator.

## **ARTICLE 4 – AVAILABILITY OF LANDS; SUBSURFACE AND PHYSICAL CONDITIONS; HAZARDOUS ENVIRONMENTAL CONDITIONS; REFERENCE POINTS**

### 4.01 *Availability of Lands*

A. Owner shall furnish the Site. Owner shall notify Contractor of any encumbrances or restrictions not of general application but specifically related to use of the Site with which Contractor must comply in performing the Work. Owner will obtain in a timely manner and pay for easements for permanent structures or permanent changes in existing facilities. If Contractor and Owner are unable to agree on entitlement to or on the amount or extent, if any, of any adjustment in the

Contract Price or Contract Times, or both, as a result of any delay in Owner's furnishing the Site or a part thereof, Contractor may make a Claim therefor as provided in Paragraph 10.05.

- B. Upon reasonable written request, Owner shall furnish Contractor with a current statement of record legal title and legal description of the lands upon which the Work is to be performed and Owner's interest therein as necessary for giving notice of or filing a mechanic's or construction lien against such lands in accordance with applicable Laws and Regulations.
- C. Contractor shall provide for all additional lands and access thereto that may be required for temporary construction facilities or storage of materials and equipment.

#### 4.02 *Subsurface and Physical Conditions*

A. *Reports and Drawings:* The Supplementary Conditions identify:

- 1. those reports known to Owner of explorations and tests of subsurface conditions at or contiguous to the Site; and
- 2. those drawings known to Owner of physical conditions relating to existing surface or subsurface structures at the Site (except Underground Facilities).

B. *Limited Reliance by Contractor on Technical Data Authorized:* Contractor may rely upon the accuracy of the "technical data" contained in such reports and drawings, but such reports and drawings are not Contract Documents. Such "technical data" is identified in the Supplementary Conditions. Except for such reliance on such "technical data," Contractor may not rely upon or make any claim against Owner or Engineer, or any of their officers, directors, members, partners, employees, agents, consultants, or subcontractors with respect to:

- 1. the completeness of such reports and drawings for Contractor's purposes, including, but not limited to, any aspects of the means, methods, techniques, sequences, and procedures of construction to be employed by Contractor, and safety precautions and programs incident thereto; or
- 2. other data, interpretations, opinions, and information contained in such reports or shown or indicated in such drawings; or
- 3. any Contractor interpretation of or conclusion drawn from any "technical data" or any such other data, interpretations, opinions, or information.

#### 4.03 *Differing Subsurface or Physical Conditions*

A. *Notice:* If Contractor believes that any subsurface or physical condition that is uncovered or revealed either:

- 1. is of such a nature as to establish that any "technical data" on which Contractor is entitled to rely as provided in Paragraph 4.02 is materially inaccurate; or
- 2. is of such a nature as to require a change in the Contract Documents; or
- 3. differs materially from that shown or indicated in the Contract Documents; or

4. is of an unusual nature, and differs materially from conditions ordinarily encountered and generally recognized as inherent in work of the character provided for in the Contract Documents;

then Contractor shall, promptly after becoming aware thereof and before further disturbing the subsurface or physical conditions or performing any Work in connection therewith (except in an emergency as required by Paragraph 6.16.A), notify Owner and Engineer in writing about such condition. Contractor shall not further disturb such condition or perform any Work in connection therewith (except as aforesaid) until receipt of written order to do so.

- B. *Engineer's Review*: After receipt of written notice as required by Paragraph 4.03.A, Engineer will promptly review the pertinent condition, determine the necessity of Owner's obtaining additional exploration or tests with respect thereto, and advise Owner in writing (with a copy to Contractor) of Engineer's findings and conclusions.

C. *Possible Price and Times Adjustments*:

1. The Contract Price or the Contract Times, or both, will be equitably adjusted to the extent that the existence of such differing subsurface or physical condition causes an increase or decrease in Contractor's cost of, or time required for, performance of the Work; subject, however, to the following:
  - a. such condition must meet any one or more of the categories described in Paragraph 4.03.A; and
  - b. with respect to Work that is paid for on a unit price basis, any adjustment in Contract Price will be subject to the provisions of Paragraphs 9.07 and 11.03.
2. Contractor shall not be entitled to any adjustment in the Contract Price or Contract Times if:
  - a. Contractor knew of the existence of such conditions at the time Contractor made a final commitment to Owner with respect to Contract Price and Contract Times by the submission of a Bid or becoming bound under a negotiated contract; or
  - b. the existence of such condition could reasonably have been discovered or revealed as a result of any examination, investigation, exploration, test, or study of the Site and contiguous areas required by the Bidding Requirements or Contract Documents to be conducted by or for Contractor prior to Contractor's making such final commitment; or
  - c. Contractor failed to give the written notice as required by Paragraph 4.03.A.
3. If Owner and Contractor are unable to agree on entitlement to or on the amount or extent, if any, of any adjustment in the Contract Price or Contract Times, or both, a Claim may be made therefor as provided in Paragraph 10.05. However, neither Owner or Engineer, or any of their officers, directors, members, partners, employees, agents, consultants, or subcontractors shall be liable to Contractor for any claims, costs, losses, or damages (including but not limited to all fees and charges of engineers, architects, attorneys, and other professionals and all court or arbitration or other dispute resolution costs) sustained by Contractor on or in connection with any other project or anticipated project.

#### 4.04 *Underground Facilities*

A. *Shown or Indicated:* The information and data shown or indicated in the Contract Documents with respect to existing Underground Facilities at or contiguous to the Site is based on information and data furnished to Owner or Engineer by the owners of such Underground Facilities, including Owner, or by others. Unless it is otherwise expressly provided in the Supplementary Conditions:

1. Owner and Engineer shall not be responsible for the accuracy or completeness of any such information or data provided by others; and
2. the cost of all of the following will be included in the Contract Price, and Contractor shall have full responsibility for:
  - a. reviewing and checking all such information and data;
  - b. locating all Underground Facilities shown or indicated in the Contract Documents;
  - c. coordination of the Work with the owners of such Underground Facilities, including Owner, during construction; and
  - d. the safety and protection of all such Underground Facilities and repairing any damage thereto resulting from the Work.

B. *Not Shown or Indicated:*

1. If an Underground Facility is uncovered or revealed at or contiguous to the Site which was not shown or indicated, or not shown or indicated with reasonable accuracy in the Contract Documents, Contractor shall, promptly after becoming aware thereof and before further disturbing conditions affected thereby or performing any Work in connection therewith (except in an emergency as required by Paragraph 6.16.A), identify the owner of such Underground Facility and give written notice to that owner and to Owner and Engineer. Engineer will promptly review the Underground Facility and determine the extent, if any, to which a change is required in the Contract Documents to reflect and document the consequences of the existence or location of the Underground Facility. During such time, Contractor shall be responsible for the safety and protection of such Underground Facility.
2. If Engineer concludes that a change in the Contract Documents is required, a Work Change Directive or a Change Order will be issued to reflect and document such consequences. An equitable adjustment shall be made in the Contract Price or Contract Times, or both, to the extent that they are attributable to the existence or location of any Underground Facility that was not shown or indicated or not shown or indicated with reasonable accuracy in the Contract Documents and that Contractor did not know of and could not reasonably have been expected to be aware of or to have anticipated. If Owner and Contractor are unable to agree on entitlement to or on the amount or extent, if any, of any such adjustment in Contract Price or Contract Times, Owner or Contractor may make a Claim therefor as provided in Paragraph 10.05.

#### 4.05 *Reference Points*

- A. Owner shall provide engineering surveys to establish reference points for construction which in Engineer's judgment are necessary to enable Contractor to proceed with the Work. Contractor shall be responsible for laying out the Work, shall protect and preserve the established reference points and property monuments, and shall make no changes or relocations without the prior written approval of Owner. Contractor shall report to Engineer whenever any reference point or property monument is lost or destroyed or requires relocation because of necessary changes in grades or locations, and shall be responsible for the accurate replacement or relocation of such reference points or property monuments by professionally qualified personnel.

#### 4.06 *Hazardous Environmental Condition at Site*

- A. *Reports and Drawings:* The Supplementary Conditions identify those reports and drawings known to Owner relating to Hazardous Environmental Conditions that have been identified at the Site.
- B. *Limited Reliance by Contractor on Technical Data Authorized:* Contractor may rely upon the accuracy of the "technical data" contained in such reports and drawings, but such reports and drawings are not Contract Documents. Such "technical data" is identified in the Supplementary Conditions. Except for such reliance on such "technical data," Contractor may not rely upon or make any claim against Owner or Engineer, or any of their officers, directors, members, partners, employees, agents, consultants, or subcontractors with respect to:
  - 1. the completeness of such reports and drawings for Contractor's purposes, including, but not limited to, any aspects of the means, methods, techniques, sequences and procedures of construction to be employed by Contractor and safety precautions and programs incident thereto; or
  - 2. other data, interpretations, opinions and information contained in such reports or shown or indicated in such drawings; or
  - 3. any Contractor interpretation of or conclusion drawn from any "technical data" or any such other data, interpretations, opinions or information.
- C. Contractor shall not be responsible for any Hazardous Environmental Condition uncovered or revealed at the Site which was not shown or indicated in Drawings or Specifications or identified in the Contract Documents to be within the scope of the Work. Contractor shall be responsible for a Hazardous Environmental Condition created with any materials brought to the Site by Contractor, Subcontractors, Suppliers, or anyone else for whom Contractor is responsible.
- D. If Contractor encounters a Hazardous Environmental Condition or if Contractor or anyone for whom Contractor is responsible creates a Hazardous Environmental Condition, Contractor shall immediately: (i) secure or otherwise isolate such condition; (ii) stop all Work in connection with such condition and in any area affected thereby (except in an emergency as required by Paragraph 6.16.A); and (iii) notify Owner and Engineer (and promptly thereafter confirm such notice in writing). Owner shall promptly consult with Engineer concerning the necessity for Owner to retain a qualified expert to evaluate such condition or take corrective action, if any. Promptly after consulting with Engineer, Owner shall take such actions as are necessary to

permit Owner to timely obtain required permits and provide Contractor the written notice required by Paragraph 4.06.E.

- E. Contractor shall not be required to resume Work in connection with such condition or in any affected area until after Owner has obtained any required permits related thereto and delivered written notice to Contractor: (i) specifying that such condition and any affected area is or has been rendered safe for the resumption of Work; or (ii) specifying any special conditions under which such Work may be resumed safely. If Owner and Contractor cannot agree as to entitlement to or on the amount or extent, if any, of any adjustment in Contract Price or Contract Times, or both, as a result of such Work stoppage or such special conditions under which Work is agreed to be resumed by Contractor, either party may make a Claim therefor as provided in Paragraph 10.05.
- F. If after receipt of such written notice Contractor does not agree to resume such Work based on a reasonable belief it is unsafe, or does not agree to resume such Work under such special conditions, then Owner may order the portion of the Work that is in the area affected by such condition to be deleted from the Work. If Owner and Contractor cannot agree as to entitlement to or on the amount or extent, if any, of an adjustment in Contract Price or Contract Times as a result of deleting such portion of the Work, then either party may make a Claim therefor as provided in Paragraph 10.05. Owner may have such deleted portion of the Work performed by Owner's own forces or others in accordance with Article 7.
- G. To the fullest extent permitted by Laws and Regulations, Owner shall indemnify and hold harmless Contractor, Subcontractors, and Engineer, and the officers, directors, members, partners, employees, agents, consultants, and subcontractors of each and any of them from and against all claims, costs, losses, and damages (including but not limited to all fees and charges of engineers, architects, attorneys, and other professionals and all court or arbitration or other dispute resolution costs) arising out of or relating to a Hazardous Environmental Condition, provided that such Hazardous Environmental Condition: (i) was not shown or indicated in the Drawings or Specifications or identified in the Contract Documents to be included within the scope of the Work, and (ii) was not created by Contractor or by anyone for whom Contractor is responsible. Nothing in this Paragraph 4.06.G shall obligate Owner to indemnify any individual or entity from and against the consequences of that individual's or entity's own negligence.
- H. To the fullest extent permitted by Laws and Regulations, Contractor shall indemnify and hold harmless Owner and Engineer, and the officers, directors, members, partners, employees, agents, consultants, and subcontractors of each and any of them from and against all claims, costs, losses, and damages (including but not limited to all fees and charges of engineers, architects, attorneys, and other professionals and all court or arbitration or other dispute resolution costs) arising out of or relating to a Hazardous Environmental Condition created by Contractor or by anyone for whom Contractor is responsible. Nothing in this Paragraph 4.06.H shall obligate Contractor to indemnify any individual or entity from and against the consequences of that individual's or entity's own negligence.
- I. The provisions of Paragraphs 4.02, 4.03, and 4.04 do not apply to a Hazardous Environmental Condition uncovered or revealed at the Site.



## ARTICLE 5 – BONDS AND INSURANCE

### 5.01 *Performance, Payment, and Other Bonds*

- A. Contractor shall furnish performance and payment bonds, each in an amount at least equal to the Contract Price as security for the faithful performance and payment of all of Contractor's obligations under the Contract Documents. These bonds shall remain in effect until one year after the date when final payment becomes due or until completion of the correction period specified in Paragraph 13.07, whichever is later, except as provided otherwise by Laws or Regulations or by the Contract Documents. Contractor shall also furnish such other bonds as are required by the Contract Documents.
- B. All bonds shall be in the form prescribed by the Contract Documents except as provided otherwise by Laws or Regulations, and shall be executed by such sureties as are named in the list of "Companies Holding Certificates of Authority as Acceptable Sureties on Federal Bonds and as Acceptable Reinsuring Companies" as published in Circular 570 (amended) by the Financial Management Service, Surety Bond Branch, U.S. Department of the Treasury. All bonds signed by an agent or attorney-in-fact must be accompanied by a certified copy of that individual's authority to bind the surety. The evidence of authority shall show that it is effective on the date the agent or attorney-in-fact signed each bond.
- C. If the surety on any bond furnished by Contractor is declared bankrupt or becomes insolvent or its right to do business is terminated in any state where any part of the Project is located or it ceases to meet the requirements of Paragraph 5.01.B, Contractor shall promptly notify Owner and Engineer and shall, within 20 days after the event giving rise to such notification, provide another bond and surety, both of which shall comply with the requirements of Paragraphs 5.01.B and 5.02.

### 5.02 *Licensed Sureties and Insurers*

- A. All bonds and insurance required by the Contract Documents to be purchased and maintained by Owner or Contractor shall be obtained from surety or insurance companies that are duly licensed or authorized in the jurisdiction in which the Project is located to issue bonds or insurance policies for the limits and coverages so required. Such surety and insurance companies shall also meet such additional requirements and qualifications as may be provided in the Supplementary Conditions.

### 5.03 *Certificates of Insurance*

- A. Contractor shall deliver to Owner, with copies to each additional insured and loss payee identified in the Supplementary Conditions, certificates of insurance (and other evidence of insurance requested by Owner or any other additional insured) which Contractor is required to purchase and maintain.
- B. Owner shall deliver to Contractor, with copies to each additional insured and loss payee identified in the Supplementary Conditions, certificates of insurance (and other evidence of insurance requested by Contractor or any other additional insured) which Owner is required to purchase and maintain.

- C. Failure of Owner to demand such certificates or other evidence of Contractor's full compliance with these insurance requirements or failure of Owner to identify a deficiency in compliance from the evidence provided shall not be construed as a waiver of Contractor's obligation to maintain such insurance.
- D. Owner does not represent that insurance coverage and limits established in this Contract necessarily will be adequate to protect Contractor.
- E. The insurance and insurance limits required herein shall not be deemed as a limitation on Contractor's liability under the indemnities granted to Owner in the Contract Documents.

5.04 *Contractor's Insurance*

- A. Contractor shall purchase and maintain such insurance as is appropriate for the Work being performed and as will provide protection from claims set forth below which may arise out of or result from Contractor's performance of the Work and Contractor's other obligations under the Contract Documents, whether it is to be performed by Contractor, any Subcontractor or Supplier, or by anyone directly or indirectly employed by any of them to perform any of the Work, or by anyone for whose acts any of them may be liable:
  - 1. claims under workers' compensation, disability benefits, and other similar employee benefit acts;
  - 2. claims for damages because of bodily injury, occupational sickness or disease, or death of Contractor's employees;
  - 3. claims for damages because of bodily injury, sickness or disease, or death of any person other than Contractor's employees;
  - 4. claims for damages insured by reasonably available personal injury liability coverage which are sustained:
    - a. by any person as a result of an offense directly or indirectly related to the employment of such person by Contractor, or
    - b. by any other person for any other reason;
  - 5. claims for damages, other than to the Work itself, because of injury to or destruction of tangible property wherever located, including loss of use resulting therefrom; and
  - 6. claims for damages because of bodily injury or death of any person or property damage arising out of the ownership, maintenance or use of any motor vehicle.
- B. The policies of insurance required by this Paragraph 5.04 shall:
  - 1. with respect to insurance required by Paragraphs 5.04.A.3 through 5.04.A.6 inclusive, be written on an occurrence basis, include as additional insureds (subject to any customary exclusion regarding professional liability) Owner and Engineer, and any other individuals or entities identified in the Supplementary Conditions, all of whom shall be listed as additional insureds, and include coverage for the respective officers, directors, members, partners,

employees, agents, consultants, and subcontractors of each and any of all such additional insureds, and the insurance afforded to these additional insureds shall provide primary coverage for all claims covered thereby;

2. include at least the specific coverages and be written for not less than the limits of liability provided in the Supplementary Conditions or required by Laws or Regulations, whichever is greater;
3. include contractual liability insurance covering Contractor's indemnity obligations under Paragraphs 6.11 and 6.20;
4. contain a provision or endorsement that the coverage afforded will not be canceled, materially changed or renewal refused until at least 30 days prior written notice has been given to Owner and Contractor and to each other additional insured identified in the Supplementary Conditions to whom a certificate of insurance has been issued (and the certificates of insurance furnished by the Contractor pursuant to Paragraph 5.03 will so provide);
5. remain in effect at least until final payment and at all times thereafter when Contractor may be correcting, removing, or replacing defective Work in accordance with Paragraph 13.07; and
6. include completed operations coverage:
  - a. Such insurance shall remain in effect for two years after final payment.
  - b. Contractor shall furnish Owner and each other additional insured identified in the Supplementary Conditions, to whom a certificate of insurance has been issued, evidence satisfactory to Owner and any such additional insured of continuation of such insurance at final payment and one year thereafter.

#### 5.05 *Owner's Liability Insurance*

- A. In addition to the insurance required to be provided by Contractor under Paragraph 5.04, Owner, at Owner's option, may purchase and maintain at Owner's expense Owner's own liability insurance as will protect Owner against claims which may arise from operations under the Contract Documents.

#### 5.06 *Property Insurance*

- A. Unless otherwise provided in the Supplementary Conditions, Owner shall purchase and maintain property insurance upon the Work at the Site in the amount of the full replacement cost thereof (subject to such deductible amounts as may be provided in the Supplementary Conditions or required by Laws and Regulations). This insurance shall:
  1. include the interests of Owner, Contractor, Subcontractors, and Engineer, and any other individuals or entities identified in the Supplementary Conditions, and the officers, directors, members, partners, employees, agents, consultants, and subcontractors of each and any of

them, each of whom is deemed to have an insurable interest and shall be listed as a loss payee;

2. be written on a Builder's Risk "all-risk" policy form that shall at least include insurance for physical loss or damage to the Work, temporary buildings, falsework, and materials and equipment in transit, and shall insure against at least the following perils or causes of loss: fire, lightning, extended coverage, theft, vandalism and malicious mischief, earthquake, collapse, debris removal, demolition occasioned by enforcement of Laws and Regulations, water damage (other than that caused by flood), and such other perils or causes of loss as may be specifically required by the Supplementary Conditions.
  3. include expenses incurred in the repair or replacement of any insured property (including but not limited to fees and charges of engineers and architects);
  4. cover materials and equipment stored at the Site or at another location that was agreed to in writing by Owner prior to being incorporated in the Work, provided that such materials and equipment have been included in an Application for Payment recommended by Engineer;
  5. allow for partial utilization of the Work by Owner;
  6. include testing and startup; and
  7. be maintained in effect until final payment is made unless otherwise agreed to in writing by Owner, Contractor, and Engineer with 30 days written notice to each other loss payee to whom a certificate of insurance has been issued.
- B. Owner shall purchase and maintain such equipment breakdown insurance or additional property insurance as may be required by the Supplementary Conditions or Laws and Regulations which will include the interests of Owner, Contractor, Subcontractors, and Engineer, and any other individuals or entities identified in the Supplementary Conditions, and the officers, directors, members, partners, employees, agents, consultants and subcontractors of each and any of them, each of whom is deemed to have an insurable interest and shall be listed as a loss payee.
- C. All the policies of insurance (and the certificates or other evidence thereof) required to be purchased and maintained in accordance with this Paragraph 5.06 will contain a provision or endorsement that the coverage afforded will not be canceled or materially changed or renewal refused until at least 30 days prior written notice has been given to Owner and Contractor and to each other loss payee to whom a certificate of insurance has been issued and will contain waiver provisions in accordance with Paragraph 5.07.
- D. Owner shall not be responsible for purchasing and maintaining any property insurance specified in this Paragraph 5.06 to protect the interests of Contractor, Subcontractors, or others in the Work to the extent of any deductible amounts that are identified in the Supplementary Conditions. The risk of loss within such identified deductible amount will be borne by Contractor, Subcontractors, or others suffering any such loss, and if any of them wishes property insurance coverage within the limits of such amounts, each may purchase and maintain it at the purchaser's own expense.

- E. If Contractor requests in writing that other special insurance be included in the property insurance policies provided under this Paragraph 5.06, Owner shall, if possible, include such insurance, and the cost thereof will be charged to Contractor by appropriate Change Order. Prior to commencement of the Work at the Site, Owner shall in writing advise Contractor whether or not such other insurance has been procured by Owner.

5.07 *Waiver of Rights*

- A. Owner and Contractor intend that all policies purchased in accordance with Paragraph 5.06 will protect Owner, Contractor, Subcontractors, and Engineer, and all other individuals or entities identified in the Supplementary Conditions as loss payees (and the officers, directors, members, partners, employees, agents, consultants, and subcontractors of each and any of them) in such policies and will provide primary coverage for all losses and damages caused by the perils or causes of loss covered thereby. All such policies shall contain provisions to the effect that in the event of payment of any loss or damage the insurers will have no rights of recovery against any of the insureds or loss payees thereunder. Owner and Contractor waive all rights against each other and their respective officers, directors, members, partners, employees, agents, consultants and subcontractors of each and any of them for all losses and damages caused by, arising out of or resulting from any of the perils or causes of loss covered by such policies and any other property insurance applicable to the Work; and, in addition, waive all such rights against Subcontractors and Engineer, and all other individuals or entities identified in the Supplementary Conditions as loss payees (and the officers, directors, members, partners, employees, agents, consultants, and subcontractors of each and any of them) under such policies for losses and damages so caused. None of the above waivers shall extend to the rights that any party making such waiver may have to the proceeds of insurance held by Owner as trustee or otherwise payable under any policy so issued.
- B. Owner waives all rights against Contractor, Subcontractors, and Engineer, and the officers, directors, members, partners, employees, agents, consultants and subcontractors of each and any of them for:
  - 1. loss due to business interruption, loss of use, or other consequential loss extending beyond direct physical loss or damage to Owner's property or the Work caused by, arising out of, or resulting from fire or other perils whether or not insured by Owner; and
  - 2. loss or damage to the completed Project or part thereof caused by, arising out of, or resulting from fire or other insured peril or cause of loss covered by any property insurance maintained on the completed Project or part thereof by Owner during partial utilization pursuant to Paragraph 14.05, after Substantial Completion pursuant to Paragraph 14.04, or after final payment pursuant to Paragraph 14.07.
- C. Any insurance policy maintained by Owner covering any loss, damage or consequential loss referred to in Paragraph 5.07.B shall contain provisions to the effect that in the event of payment of any such loss, damage, or consequential loss, the insurers will have no rights of recovery against Contractor, Subcontractors, or Engineer, and the officers, directors, members, partners, employees, agents, consultants and subcontractors of each and any of them.

5.08 *Receipt and Application of Insurance Proceeds*

- A. Any insured loss under the policies of insurance required by Paragraph 5.06 will be adjusted with Owner and made payable to Owner as fiduciary for the loss payees, as their interests may appear, subject to the requirements of any applicable mortgage clause and of Paragraph 5.08.B. Owner shall deposit in a separate account any money so received and shall distribute it in accordance with such agreement as the parties in interest may reach. If no other special agreement is reached, the damaged Work shall be repaired or replaced, the moneys so received applied on account thereof, and the Work and the cost thereof covered by an appropriate Change Order.
- B. Owner as fiduciary shall have power to adjust and settle any loss with the insurers unless one of the parties in interest shall object in writing within 15 days after the occurrence of loss to Owner's exercise of this power. If such objection be made, Owner as fiduciary shall make settlement with the insurers in accordance with such agreement as the parties in interest may reach. If no such agreement among the parties in interest is reached, Owner as fiduciary shall adjust and settle the loss with the insurers and, if required in writing by any party in interest, Owner as fiduciary shall give bond for the proper performance of such duties.

5.09 *Acceptance of Bonds and Insurance; Option to Replace*

- A. If either Owner or Contractor has any objection to the coverage afforded by or other provisions of the bonds or insurance required to be purchased and maintained by the other party in accordance with Article 5 on the basis of non-conformance with the Contract Documents, the objecting party shall so notify the other party in writing within 10 days after receipt of the certificates (or other evidence requested) required by Paragraph 2.01.B. Owner and Contractor shall each provide to the other such additional information in respect of insurance provided as the other may reasonably request. If either party does not purchase or maintain all of the bonds and insurance required of such party by the Contract Documents, such party shall notify the other party in writing of such failure to purchase prior to the start of the Work, or of such failure to maintain prior to any change in the required coverage. Without prejudice to any other right or remedy, the other party may elect to obtain equivalent bonds or insurance to protect such other party's interests at the expense of the party who was required to provide such coverage, and a Change Order shall be issued to adjust the Contract Price accordingly.

5.10 *Partial Utilization, Acknowledgment of Property Insurer*

- A. If Owner finds it necessary to occupy or use a portion or portions of the Work prior to Substantial Completion of all the Work as provided in Paragraph 14.05, no such use or occupancy shall commence before the insurers providing the property insurance pursuant to Paragraph 5.06 have acknowledged notice thereof and in writing effected any changes in coverage necessitated thereby. The insurers providing the property insurance shall consent by endorsement on the policy or policies, but the property insurance shall not be canceled or permitted to lapse on account of any such partial use or occupancy.

## ARTICLE 6 – CONTRACTOR’S RESPONSIBILITIES

### 6.01 *Supervision and Superintendence*

- A. Contractor shall supervise, inspect, and direct the Work competently and efficiently, devoting such attention thereto and applying such skills and expertise as may be necessary to perform the Work in accordance with the Contract Documents. Contractor shall be solely responsible for the means, methods, techniques, sequences, and procedures of construction. Contractor shall not be responsible for the negligence of Owner or Engineer in the design or specification of a specific means, method, technique, sequence, or procedure of construction which is shown or indicated in and expressly required by the Contract Documents.
- B. At all times during the progress of the Work, Contractor shall assign a competent resident superintendent who shall not be replaced without written notice to Owner and Engineer except under extraordinary circumstances.

### 6.02 *Labor; Working Hours*

- A. Contractor shall provide competent, suitably qualified personnel to survey and lay out the Work and perform construction as required by the Contract Documents. Contractor shall at all times maintain good discipline and order at the Site.
- B. Except as otherwise required for the safety or protection of persons or the Work or property at the Site or adjacent thereto, and except as otherwise stated in the Contract Documents, all Work at the Site shall be performed during regular working hours. Contractor will not permit the performance of Work on a Saturday, Sunday, or any legal holiday without Owner’s written consent (which will not be unreasonably withheld) given after prior written notice to Engineer.

### 6.03 *Services, Materials, and Equipment*

- A. Unless otherwise specified in the Contract Documents, Contractor shall provide and assume full responsibility for all services, materials, equipment, labor, transportation, construction equipment and machinery, tools, appliances, fuel, power, light, heat, telephone, water, sanitary facilities, temporary facilities, and all other facilities and incidentals necessary for the performance, testing, start-up, and completion of the Work.
- B. All materials and equipment incorporated into the Work shall be as specified or, if not specified, shall be of good quality and new, except as otherwise provided in the Contract Documents. All special warranties and guarantees required by the Specifications shall expressly run to the benefit of Owner. If required by Engineer, Contractor shall furnish satisfactory evidence (including reports of required tests) as to the source, kind, and quality of materials and equipment.
- C. All materials and equipment shall be stored, applied, installed, connected, erected, protected, used, cleaned, and conditioned in accordance with instructions of the applicable Supplier, except as otherwise may be provided in the Contract Documents.

6.04 *Progress Schedule*

- A. Contractor shall adhere to the Progress Schedule established in accordance with Paragraph 2.07 as it may be adjusted from time to time as provided below.
1. Contractor shall submit to Engineer for acceptance (to the extent indicated in Paragraph 2.07) proposed adjustments in the Progress Schedule that will not result in changing the Contract Times. Such adjustments will comply with any provisions of the General Requirements applicable thereto.
  2. Proposed adjustments in the Progress Schedule that will change the Contract Times shall be submitted in accordance with the requirements of Article 12. Adjustments in Contract Times may only be made by a Change Order.

6.05 *Substitutes and "Or-Equals"*

- A. Whenever an item of material or equipment is specified or described in the Contract Documents by using the name of a proprietary item or the name of a particular Supplier, the specification or description is intended to establish the type, function, appearance, and quality required. Unless the specification or description contains or is followed by words reading that no like, equivalent, or "or-equal" item or no substitution is permitted, other items of material or equipment or material or equipment of other Suppliers may be submitted to Engineer for review under the circumstances described below.
1. "*Or-Equal*" Items: If in Engineer's sole discretion an item of material or equipment proposed by Contractor is functionally equal to that named and sufficiently similar so that no change in related Work will be required, it may be considered by Engineer as an "or-equal" item, in which case review and approval of the proposed item may, in Engineer's sole discretion, be accomplished without compliance with some or all of the requirements for approval of proposed substitute items. For the purposes of this Paragraph 6.05.A.1, a proposed item of material or equipment will be considered functionally equal to an item so named if:
    - a. in the exercise of reasonable judgment Engineer determines that:
      - 1) it is at least equal in materials of construction, quality, durability, appearance, strength, and design characteristics;
      - 2) it will reliably perform at least equally well the function and achieve the results imposed by the design concept of the completed Project as a functioning whole; and
      - 3) it has a proven record of performance and availability of responsive service.
    - b. Contractor certifies that, if approved and incorporated into the Work:
      - 1) there will be no increase in cost to the Owner or increase in Contract Times; and
      - 2) it will conform substantially to the detailed requirements of the item named in the Contract Documents.



2. *Substitute Items:*

- a. If in Engineer's sole discretion an item of material or equipment proposed by Contractor does not qualify as an "or-equal" item under Paragraph 6.05.A.1, it will be considered a proposed substitute item.
- b. Contractor shall submit sufficient information as provided below to allow Engineer to determine if the item of material or equipment proposed is essentially equivalent to that named and an acceptable substitute therefor. Requests for review of proposed substitute items of material or equipment will not be accepted by Engineer from anyone other than Contractor.
- c. The requirements for review by Engineer will be as set forth in Paragraph 6.05.A.2.d, as supplemented by the General Requirements, and as Engineer may decide is appropriate under the circumstances.
- d. Contractor shall make written application to Engineer for review of a proposed substitute item of material or equipment that Contractor seeks to furnish or use. The application:
  - 1) shall certify that the proposed substitute item will:
    - a) perform adequately the functions and achieve the results called for by the general design,
    - b) be similar in substance to that specified, and
    - c) be suited to the same use as that specified;
  - 2) will state:
    - a) the extent, if any, to which the use of the proposed substitute item will prejudice Contractor's achievement of Substantial Completion on time,
    - b) whether use of the proposed substitute item in the Work will require a change in any of the Contract Documents (or in the provisions of any other direct contract with Owner for other work on the Project) to adapt the design to the proposed substitute item, and
    - c) whether incorporation or use of the proposed substitute item in connection with the Work is subject to payment of any license fee or royalty;
  - 3) will identify:
    - a) all variations of the proposed substitute item from that specified, and
    - b) available engineering, sales, maintenance, repair, and replacement services; and
  - 4) shall contain an itemized estimate of all costs or credits that will result directly or indirectly from use of such substitute item, including costs of redesign and claims of other contractors affected by any resulting change.

- B. *Substitute Construction Methods or Procedures:* If a specific means, method, technique, sequence, or procedure of construction is expressly required by the Contract Documents, Contractor may furnish or utilize a substitute means, method, technique, sequence, or procedure of construction approved by Engineer. Contractor shall submit sufficient information to allow Engineer, in Engineer's sole discretion, to determine that the substitute proposed is equivalent to that expressly called for by the Contract Documents. The requirements for review by Engineer will be similar to those provided in Paragraph 6.05.A.2.
- C. *Engineer's Evaluation:* Engineer will be allowed a reasonable time within which to evaluate each proposal or submittal made pursuant to Paragraphs 6.05.A and 6.05.B. Engineer may require Contractor to furnish additional data about the proposed substitute item. Engineer will be the sole judge of acceptability. No "or equal" or substitute will be ordered, installed or utilized until Engineer's review is complete, which will be evidenced by a Change Order in the case of a substitute and an approved Shop Drawing for an "or equal." Engineer will advise Contractor in writing of any negative determination.
- D. *Special Guarantee:* Owner may require Contractor to furnish at Contractor's expense a special performance guarantee or other surety with respect to any substitute.
- E. *Engineer's Cost Reimbursement:* Engineer will record Engineer's costs in evaluating a substitute proposed or submitted by Contractor pursuant to Paragraphs 6.05.A.2 and 6.05.B. Whether or not Engineer approves a substitute so proposed or submitted by Contractor, Contractor shall reimburse Owner for the reasonable charges of Engineer for evaluating each such proposed substitute. Contractor shall also reimburse Owner for the reasonable charges of Engineer for making changes in the Contract Documents (or in the provisions of any other direct contract with Owner) resulting from the acceptance of each proposed substitute.
- F. *Contractor's Expense:* Contractor shall provide all data in support of any proposed substitute or "or-equal" at Contractor's expense.

#### 6.06 *Concerning Subcontractors, Suppliers, and Others*

- A. Contractor shall not employ any Subcontractor, Supplier, or other individual or entity (including those acceptable to Owner as indicated in Paragraph 6.06.B), whether initially or as a replacement, against whom Owner may have reasonable objection. Contractor shall not be required to employ any Subcontractor, Supplier, or other individual or entity to furnish or perform any of the Work against whom Contractor has reasonable objection.
- B. If the Supplementary Conditions require the identity of certain Subcontractors, Suppliers, or other individuals or entities to be submitted to Owner in advance for acceptance by Owner by a specified date prior to the Effective Date of the Agreement, and if Contractor has submitted a list thereof in accordance with the Supplementary Conditions, Owner's acceptance (either in writing or by failing to make written objection thereto by the date indicated for acceptance or objection in the Bidding Documents or the Contract Documents) of any such Subcontractor, Supplier, or other individual or entity so identified may be revoked on the basis of reasonable objection after due investigation. Contractor shall submit an acceptable replacement for the rejected Subcontractor, Supplier, or other individual or entity, and the Contract Price will be adjusted by the difference in the cost occasioned by such replacement, and an appropriate Change Order will be issued. No acceptance by Owner of any such Subcontractor, Supplier, or other individual or

entity, whether initially or as a replacement, shall constitute a waiver of any right of Owner or Engineer to reject defective Work.

- C. Contractor shall be fully responsible to Owner and Engineer for all acts and omissions of the Subcontractors, Suppliers, and other individuals or entities performing or furnishing any of the Work just as Contractor is responsible for Contractor's own acts and omissions. Nothing in the Contract Documents:
1. shall create for the benefit of any such Subcontractor, Supplier, or other individual or entity any contractual relationship between Owner or Engineer and any such Subcontractor, Supplier or other individual or entity; nor
  2. shall create any obligation on the part of Owner or Engineer to pay or to see to the payment of any moneys due any such Subcontractor, Supplier, or other individual or entity except as may otherwise be required by Laws and Regulations.
- D. Contractor shall be solely responsible for scheduling and coordinating the Work of Subcontractors, Suppliers, and other individuals or entities performing or furnishing any of the Work under a direct or indirect contract with Contractor.
- E. Contractor shall require all Subcontractors, Suppliers, and such other individuals or entities performing or furnishing any of the Work to communicate with Engineer through Contractor.
- F. The divisions and sections of the Specifications and the identifications of any Drawings shall not control Contractor in dividing the Work among Subcontractors or Suppliers or delineating the Work to be performed by any specific trade.
- G. All Work performed for Contractor by a Subcontractor or Supplier will be pursuant to an appropriate agreement between Contractor and the Subcontractor or Supplier which specifically binds the Subcontractor or Supplier to the applicable terms and conditions of the Contract Documents for the benefit of Owner and Engineer. Whenever any such agreement is with a Subcontractor or Supplier who is listed as a loss payee on the property insurance provided in Paragraph 5.06, the agreement between the Contractor and the Subcontractor or Supplier will contain provisions whereby the Subcontractor or Supplier waives all rights against Owner, Contractor, Engineer, and all other individuals or entities identified in the Supplementary Conditions to be listed as insureds or loss payees (and the officers, directors, members, partners, employees, agents, consultants, and subcontractors of each and any of them) for all losses and damages caused by, arising out of, relating to, or resulting from any of the perils or causes of loss covered by such policies and any other property insurance applicable to the Work. If the insurers on any such policies require separate waiver forms to be signed by any Subcontractor or Supplier, Contractor will obtain the same.

#### 6.07 *Patent Fees and Royalties*

- A. Contractor shall pay all license fees and royalties and assume all costs incident to the use in the performance of the Work or the incorporation in the Work of any invention, design, process, product, or device which is the subject of patent rights or copyrights held by others. If a particular invention, design, process, product, or device is specified in the Contract Documents for use in the performance of the Work and if, to the actual knowledge of Owner or Engineer, its

use is subject to patent rights or copyrights calling for the payment of any license fee or royalty to others, the existence of such rights shall be disclosed by Owner in the Contract Documents.

- B. To the fullest extent permitted by Laws and Regulations, Owner shall indemnify and hold harmless Contractor, and its officers, directors, members, partners, employees, agents, consultants, and subcontractors from and against all claims, costs, losses, and damages (including but not limited to all fees and charges of engineers, architects, attorneys, and other professionals, and all court or arbitration or other dispute resolution costs) arising out of or relating to any infringement of patent rights or copyrights incident to the use in the performance of the Work or resulting from the incorporation in the Work of any invention, design, process, product, or device specified in the Contract Documents, but not identified as being subject to payment of any license fee or royalty to others required by patent rights or copyrights.
- C. To the fullest extent permitted by Laws and Regulations, Contractor shall indemnify and hold harmless Owner and Engineer, and the officers, directors, members, partners, employees, agents, consultants and subcontractors of each and any of them from and against all claims, costs, losses, and damages (including but not limited to all fees and charges of engineers, architects, attorneys, and other professionals and all court or arbitration or other dispute resolution costs) arising out of or relating to any infringement of patent rights or copyrights incident to the use in the performance of the Work or resulting from the incorporation in the Work of any invention, design, process, product, or device not specified in the Contract Documents.

#### 6.08 *Permits*

- A. Unless otherwise provided in the Supplementary Conditions, Contractor shall obtain and pay for all construction permits and licenses. Owner shall assist Contractor, when necessary, in obtaining such permits and licenses. Contractor shall pay all governmental charges and inspection fees necessary for the prosecution of the Work which are applicable at the time of opening of Bids, or, if there are no Bids, on the Effective Date of the Agreement. Owner shall pay all charges of utility owners for connections for providing permanent service to the Work.

#### 6.09 *Laws and Regulations*

- A. Contractor shall give all notices required by and shall comply with all Laws and Regulations applicable to the performance of the Work. Except where otherwise expressly required by applicable Laws and Regulations, neither Owner nor Engineer shall be responsible for monitoring Contractor's compliance with any Laws or Regulations.
- B. If Contractor performs any Work knowing or having reason to know that it is contrary to Laws or Regulations, Contractor shall bear all claims, costs, losses, and damages (including but not limited to all fees and charges of engineers, architects, attorneys, and other professionals and all court or arbitration or other dispute resolution costs) arising out of or relating to such Work. However, it shall not be Contractor's responsibility to make certain that the Specifications and Drawings are in accordance with Laws and Regulations, but this shall not relieve Contractor of Contractor's obligations under Paragraph 3.03.
- C. Changes in Laws or Regulations not known at the time of opening of Bids (or, on the Effective Date of the Agreement if there were no Bids) having an effect on the cost or time of performance of the Work shall be the subject of an adjustment in Contract Price or Contract Times. If Owner

and Contractor are unable to agree on entitlement to or on the amount or extent, if any, of any such adjustment, a Claim may be made therefore as provided in Paragraph 10.05.

#### 6.10 *Taxes*

- A. Contractor shall pay all sales, consumer, use, and other similar taxes required to be paid by Contractor in accordance with the Laws and Regulations of the place of the Project which are applicable during the performance of the Work.

#### 6.11 *Use of Site and Other Areas*

##### A. *Limitation on Use of Site and Other Areas:*

1. Contractor shall confine construction equipment, the storage of materials and equipment, and the operations of workers to the Site and other areas permitted by Laws and Regulations, and shall not unreasonably encumber the Site and other areas with construction equipment or other materials or equipment. Contractor shall assume full responsibility for any damage to any such land or area, or to the owner or occupant thereof, or of any adjacent land or areas resulting from the performance of the Work.
2. Should any claim be made by any such owner or occupant because of the performance of the Work, Contractor shall promptly settle with such other party by negotiation or otherwise resolve the claim by arbitration or other dispute resolution proceeding or at law.
3. To the fullest extent permitted by Laws and Regulations, Contractor shall indemnify and hold harmless Owner and Engineer, and the officers, directors, members, partners, employees, agents, consultants and subcontractors of each and any of them from and against all claims, costs, losses, and damages (including but not limited to all fees and charges of engineers, architects, attorneys, and other professionals and all court or arbitration or other dispute resolution costs) arising out of or relating to any claim or action, legal or equitable, brought by any such owner or occupant against Owner, Engineer, or any other party indemnified hereunder to the extent caused by or based upon Contractor's performance of the Work.

B. *Removal of Debris During Performance of the Work:* During the progress of the Work Contractor shall keep the Site and other areas free from accumulations of waste materials, rubbish, and other debris. Removal and disposal of such waste materials, rubbish, and other debris shall conform to applicable Laws and Regulations.

C. *Cleaning:* Prior to Substantial Completion of the Work Contractor shall clean the Site and the Work and make it ready for utilization by Owner. At the completion of the Work Contractor shall remove from the Site all tools, appliances, construction equipment and machinery, and surplus materials and shall restore to original condition all property not designated for alteration by the Contract Documents.

D. *Loading Structures:* Contractor shall not load nor permit any part of any structure to be loaded in any manner that will endanger the structure, nor shall Contractor subject any part of the Work or adjacent property to stresses or pressures that will endanger it.

## 6.12 *Record Documents*

- A. Contractor shall maintain in a safe place at the Site one record copy of all Drawings, Specifications, Addenda, Change Orders, Work Change Directives, Field Orders, and written interpretations and clarifications in good order and annotated to show changes made during construction. These record documents together with all approved Samples and a counterpart of all approved Shop Drawings will be available to Engineer for reference. Upon completion of the Work, these record documents, Samples, and Shop Drawings will be delivered to Engineer for Owner.

## 6.13 *Safety and Protection*

- A. Contractor shall be solely responsible for initiating, maintaining and supervising all safety precautions and programs in connection with the Work. Such responsibility does not relieve Subcontractors of their responsibility for the safety of persons or property in the performance of their work, nor for compliance with applicable safety Laws and Regulations. Contractor shall take all necessary precautions for the safety of, and shall provide the necessary protection to prevent damage, injury or loss to:
  - 1. all persons on the Site or who may be affected by the Work;
  - 2. all the Work and materials and equipment to be incorporated therein, whether in storage on or off the Site; and
  - 3. other property at the Site or adjacent thereto, including trees, shrubs, lawns, walks, pavements, roadways, structures, utilities, and Underground Facilities not designated for removal, relocation, or replacement in the course of construction.
- B. Contractor shall comply with all applicable Laws and Regulations relating to the safety of persons or property, or to the protection of persons or property from damage, injury, or loss; and shall erect and maintain all necessary safeguards for such safety and protection. Contractor shall notify owners of adjacent property and of Underground Facilities and other utility owners when prosecution of the Work may affect them, and shall cooperate with them in the protection, removal, relocation, and replacement of their property.
- C. Contractor shall comply with the applicable requirements of Owner's safety programs, if any. The Supplementary Conditions identify any Owner's safety programs that are applicable to the Work.
- D. Contractor shall inform Owner and Engineer of the specific requirements of Contractor's safety program with which Owner's and Engineer's employees and representatives must comply while at the Site.
- E. All damage, injury, or loss to any property referred to in Paragraph 6.13.A.2 or 6.13.A.3 caused, directly or indirectly, in whole or in part, by Contractor, any Subcontractor, Supplier, or any other individual or entity directly or indirectly employed by any of them to perform any of the Work, or anyone for whose acts any of them may be liable, shall be remedied by Contractor (except damage or loss attributable to the fault of Drawings or Specifications or to the acts or omissions of Owner or Engineer or anyone employed by any of them, or anyone for whose acts

any of them may be liable, and not attributable, directly or indirectly, in whole or in part, to the fault or negligence of Contractor or any Subcontractor, Supplier, or other individual or entity directly or indirectly employed by any of them).

- F. Contractor's duties and responsibilities for safety and for protection of the Work shall continue until such time as all the Work is completed and Engineer has issued a notice to Owner and Contractor in accordance with Paragraph 14.07.B that the Work is acceptable (except as otherwise expressly provided in connection with Substantial Completion).

#### 6.14 *Safety Representative*

- A. Contractor shall designate a qualified and experienced safety representative at the Site whose duties and responsibilities shall be the prevention of accidents and the maintaining and supervising of safety precautions and programs.

#### 6.15 *Hazard Communication Programs*

- A. Contractor shall be responsible for coordinating any exchange of material safety data sheets or other hazard communication information required to be made available to or exchanged between or among employers at the Site in accordance with Laws or Regulations.

#### 6.16 *Emergencies*

- A. In emergencies affecting the safety or protection of persons or the Work or property at the Site or adjacent thereto, Contractor is obligated to act to prevent threatened damage, injury, or loss. Contractor shall give Engineer prompt written notice if Contractor believes that any significant changes in the Work or variations from the Contract Documents have been caused thereby or are required as a result thereof. If Engineer determines that a change in the Contract Documents is required because of the action taken by Contractor in response to such an emergency, a Work Change Directive or Change Order will be issued.

#### 6.17 *Shop Drawings and Samples*

- A. Contractor shall submit Shop Drawings and Samples to Engineer for review and approval in accordance with the accepted Schedule of Submittals (as required by Paragraph 2.07). Each submittal will be identified as Engineer may require.

##### 1. *Shop Drawings:*

- a. Submit number of copies specified in the General Requirements.
- b. Data shown on the Shop Drawings will be complete with respect to quantities, dimensions, specified performance and design criteria, materials, and similar data to show Engineer the services, materials, and equipment Contractor proposes to provide and to enable Engineer to review the information for the limited purposes required by Paragraph 6.17.D.

##### 2. *Samples:*

- a. Submit number of Samples specified in the Specifications.

- b. Clearly identify each Sample as to material, Supplier, pertinent data such as catalog numbers, the use for which intended and other data as Engineer may require to enable Engineer to review the submittal for the limited purposes required by Paragraph 6.17.D.
- B. Where a Shop Drawing or Sample is required by the Contract Documents or the Schedule of Submittals, any related Work performed prior to Engineer's review and approval of the pertinent submittal will be at the sole expense and responsibility of Contractor.

C. *Submittal Procedures:*

1. Before submitting each Shop Drawing or Sample, Contractor shall have:
  - a. reviewed and coordinated each Shop Drawing or Sample with other Shop Drawings and Samples and with the requirements of the Work and the Contract Documents;
  - b. determined and verified all field measurements, quantities, dimensions, specified performance and design criteria, installation requirements, materials, catalog numbers, and similar information with respect thereto;
  - c. determined and verified the suitability of all materials offered with respect to the indicated application, fabrication, shipping, handling, storage, assembly, and installation pertaining to the performance of the Work; and
  - d. determined and verified all information relative to Contractor's responsibilities for means, methods, techniques, sequences, and procedures of construction, and safety precautions and programs incident thereto.
2. Each submittal shall bear a stamp or specific written certification that Contractor has satisfied Contractor's obligations under the Contract Documents with respect to Contractor's review and approval of that submittal.
3. With each submittal, Contractor shall give Engineer specific written notice of any variations that the Shop Drawing or Sample may have from the requirements of the Contract Documents. This notice shall be both a written communication separate from the Shop Drawings or Sample submittal; and, in addition, by a specific notation made on each Shop Drawing or Sample submitted to Engineer for review and approval of each such variation.

D. *Engineer's Review:*

1. Engineer will provide timely review of Shop Drawings and Samples in accordance with the Schedule of Submittals acceptable to Engineer. Engineer's review and approval will be only to determine if the items covered by the submittals will, after installation or incorporation in the Work, conform to the information given in the Contract Documents and be compatible with the design concept of the completed Project as a functioning whole as indicated by the Contract Documents.
2. Engineer's review and approval will not extend to means, methods, techniques, sequences, or procedures of construction (except where a particular means, method, technique, sequence, or procedure of construction is specifically and expressly called for by the



Contract Documents) or to safety precautions or programs incident thereto. The review and approval of a separate item as such will not indicate approval of the assembly in which the item functions.

3. Engineer's review and approval shall not relieve Contractor from responsibility for any variation from the requirements of the Contract Documents unless Contractor has complied with the requirements of Paragraph 6.17.C.3 and Engineer has given written approval of each such variation by specific written notation thereof incorporated in or accompanying the Shop Drawing or Sample. Engineer's review and approval shall not relieve Contractor from responsibility for complying with the requirements of Paragraph 6.17.C.1.

E. *Resubmittal Procedures:*

1. Contractor shall make corrections required by Engineer and shall return the required number of corrected copies of Shop Drawings and submit, as required, new Samples for review and approval. Contractor shall direct specific attention in writing to revisions other than the corrections called for by Engineer on previous submittals.

6.18 *Continuing the Work*

- A. Contractor shall carry on the Work and adhere to the Progress Schedule during all disputes or disagreements with Owner. No Work shall be delayed or postponed pending resolution of any disputes or disagreements, except as permitted by Paragraph 15.04 or as Owner and Contractor may otherwise agree in writing.

6.19 *Contractor's General Warranty and Guarantee*

- A. Contractor warrants and guarantees to Owner that all Work will be in accordance with the Contract Documents and will not be defective. Engineer and its officers, directors, members, partners, employees, agents, consultants, and subcontractors shall be entitled to rely on representation of Contractor's warranty and guarantee.
- B. Contractor's warranty and guarantee hereunder excludes defects or damage caused by:
  1. abuse, modification, or improper maintenance or operation by persons other than Contractor, Subcontractors, Suppliers, or any other individual or entity for whom Contractor is responsible; or
  2. normal wear and tear under normal usage.
- C. Contractor's obligation to perform and complete the Work in accordance with the Contract Documents shall be absolute. None of the following will constitute an acceptance of Work that is not in accordance with the Contract Documents or a release of Contractor's obligation to perform the Work in accordance with the Contract Documents:
  1. observations by Engineer;
  2. recommendation by Engineer or payment by Owner of any progress or final payment;

3. the issuance of a certificate of Substantial Completion by Engineer or any payment related thereto by Owner;
4. use or occupancy of the Work or any part thereof by Owner;
5. any review and approval of a Shop Drawing or Sample submittal or the issuance of a notice of acceptability by Engineer;
6. any inspection, test, or approval by others; or
7. any correction of defective Work by Owner.

#### 6.20 *Indemnification*

- A. To the fullest extent permitted by Laws and Regulations, Contractor shall indemnify and hold harmless Owner and Engineer, and the officers, directors, members, partners, employees, agents, consultants and subcontractors of each and any of them from and against all claims, costs, losses, and damages (including but not limited to all fees and charges of engineers, architects, attorneys, and other professionals and all court or arbitration or other dispute resolution costs) arising out of or relating to the performance of the Work, provided that any such claim, cost, loss, or damage is attributable to bodily injury, sickness, disease, or death, or to injury to or destruction of tangible property (other than the Work itself), including the loss of use resulting therefrom but only to the extent caused by any negligent act or omission of Contractor, any Subcontractor, any Supplier, or any individual or entity directly or indirectly employed by any of them to perform any of the Work or anyone for whose acts any of them may be liable .
- B. In any and all claims against Owner or Engineer or any of their officers, directors, members, partners, employees, agents, consultants, or subcontractors by any employee (or the survivor or personal representative of such employee) of Contractor, any Subcontractor, any Supplier, or any individual or entity directly or indirectly employed by any of them to perform any of the Work, or anyone for whose acts any of them may be liable, the indemnification obligation under Paragraph 6.20.A shall not be limited in any way by any limitation on the amount or type of damages, compensation, or benefits payable by or for Contractor or any such Subcontractor, Supplier, or other individual or entity under workers' compensation acts, disability benefit acts, or other employee benefit acts.
- C. The indemnification obligations of Contractor under Paragraph 6.20.A shall not extend to the liability of Engineer and Engineer's officers, directors, members, partners, employees, agents, consultants and subcontractors arising out of:
  1. the preparation or approval of, or the failure to prepare or approve maps, Drawings, opinions, reports, surveys, Change Orders, designs, or Specifications; or
  2. giving directions or instructions, or failing to give them, if that is the primary cause of the injury or damage.

## 6.21 *Delegation of Professional Design Services*

- A. Contractor will not be required to provide professional design services unless such services are specifically required by the Contract Documents for a portion of the Work or unless such services are required to carry out Contractor's responsibilities for construction means, methods, techniques, sequences and procedures. Contractor shall not be required to provide professional services in violation of applicable law.
- B. If professional design services or certifications by a design professional related to systems, materials or equipment are specifically required of Contractor by the Contract Documents, Owner and Engineer will specify all performance and design criteria that such services must satisfy. Contractor shall cause such services or certifications to be provided by a properly licensed professional, whose signature and seal shall appear on all drawings, calculations, specifications, certifications, Shop Drawings and other submittals prepared by such professional. Shop Drawings and other submittals related to the Work designed or certified by such professional, if prepared by others, shall bear such professional's written approval when submitted to Engineer.
- C. Owner and Engineer shall be entitled to rely upon the adequacy, accuracy and completeness of the services, certifications or approvals performed by such design professionals, provided Owner and Engineer have specified to Contractor all performance and design criteria that such services must satisfy.
- D. Pursuant to this Paragraph 6.21, Engineer's review and approval of design calculations and design drawings will be only for the limited purpose of checking for conformance with performance and design criteria given and the design concept expressed in the Contract Documents. Engineer's review and approval of Shop Drawings and other submittals (except design calculations and design drawings) will be only for the purpose stated in Paragraph 6.17.D.1.
- E. Contractor shall not be responsible for the adequacy of the performance or design criteria required by the Contract Documents.

## **ARTICLE 7 – OTHER WORK AT THE SITE**

### 7.01 *Related Work at Site*

- A. Owner may perform other work related to the Project at the Site with Owner's employees, or through other direct contracts therefor, or have other work performed by utility owners. If such other work is not noted in the Contract Documents, then:
  - 1. written notice thereof will be given to Contractor prior to starting any such other work; and
  - 2. if Owner and Contractor are unable to agree on entitlement to or on the amount or extent, if any, of any adjustment in the Contract Price or Contract Times that should be allowed as a result of such other work, a Claim may be made therefor as provided in Paragraph 10.05.
- B. Contractor shall afford each other contractor who is a party to such a direct contract, each utility owner, and Owner, if Owner is performing other work with Owner's employees, proper and safe

access to the Site, provide a reasonable opportunity for the introduction and storage of materials and equipment and the execution of such other work, and properly coordinate the Work with theirs. Contractor shall do all cutting, fitting, and patching of the Work that may be required to properly connect or otherwise make its several parts come together and properly integrate with such other work. Contractor shall not endanger any work of others by cutting, excavating, or otherwise altering such work; provided, however, that Contractor may cut or alter others' work with the written consent of Engineer and the others whose work will be affected. The duties and responsibilities of Contractor under this Paragraph are for the benefit of such utility owners and other contractors to the extent that there are comparable provisions for the benefit of Contractor in said direct contracts between Owner and such utility owners and other contractors.

- C. If the proper execution or results of any part of Contractor's Work depends upon work performed by others under this Article 7, Contractor shall inspect such other work and promptly report to Engineer in writing any delays, defects, or deficiencies in such other work that render it unavailable or unsuitable for the proper execution and results of Contractor's Work. Contractor's failure to so report will constitute an acceptance of such other work as fit and proper for integration with Contractor's Work except for latent defects and deficiencies in such other work.

#### 7.02 *Coordination*

- A. If Owner intends to contract with others for the performance of other work on the Project at the Site, the following will be set forth in Supplementary Conditions:
  - 1. the individual or entity who will have authority and responsibility for coordination of the activities among the various contractors will be identified;
  - 2. the specific matters to be covered by such authority and responsibility will be itemized; and
  - 3. the extent of such authority and responsibilities will be provided.
- B. Unless otherwise provided in the Supplementary Conditions, Owner shall have sole authority and responsibility for such coordination.

#### 7.03 *Legal Relationships*

- A. Paragraphs 7.01.A and 7.02 are not applicable for utilities not under the control of Owner.
- B. Each other direct contract of Owner under Paragraph 7.01.A shall provide that the other contractor is liable to Owner and Contractor for the reasonable direct delay and disruption costs incurred by Contractor as a result of the other contractor's wrongful actions or inactions.
- C. Contractor shall be liable to Owner and any other contractor under direct contract to Owner for the reasonable direct delay and disruption costs incurred by such other contractor as a result of Contractor's wrongful action or inactions.

## ARTICLE 8 – OWNER’S RESPONSIBILITIES

### 8.01 *Communications to Contractor*

- A. Except as otherwise provided in these General Conditions, Owner shall issue all communications to Contractor through Engineer.

### 8.02 *Replacement of Engineer*

- A. In case of termination of the employment of Engineer, Owner shall appoint an engineer to whom Contractor makes no reasonable objection, whose status under the Contract Documents shall be that of the former Engineer.

### 8.03 *Furnish Data*

- A. Owner shall promptly furnish the data required of Owner under the Contract Documents.

### 8.04 *Pay When Due*

- A. Owner shall make payments to Contractor when they are due as provided in Paragraphs 14.02.C and 14.07.C.

### 8.05 *Lands and Easements; Reports and Tests*

- A. Owner’s duties with respect to providing lands and easements and providing engineering surveys to establish reference points are set forth in Paragraphs 4.01 and 4.05. Paragraph 4.02 refers to Owner’s identifying and making available to Contractor copies of reports of explorations and tests of subsurface conditions and drawings of physical conditions relating to existing surface or subsurface structures at the Site.

### 8.06 *Insurance*

- A. Owner’s responsibilities, if any, with respect to purchasing and maintaining liability and property insurance are set forth in Article 5.

### 8.07 *Change Orders*

- A. Owner is obligated to execute Change Orders as indicated in Paragraph 10.03.

### 8.08 *Inspections, Tests, and Approvals*

- A. Owner’s responsibility with respect to certain inspections, tests, and approvals is set forth in Paragraph 13.03.B.

### 8.09 *Limitations on Owner’s Responsibilities*

- A. The Owner shall not supervise, direct, or have control or authority over, nor be responsible for, Contractor’s means, methods, techniques, sequences, or procedures of construction, or the safety precautions and programs incident thereto, or for any failure of Contractor to comply with Laws

and Regulations applicable to the performance of the Work. Owner will not be responsible for Contractor's failure to perform the Work in accordance with the Contract Documents.

8.10 *Undisclosed Hazardous Environmental Condition*

A. Owner's responsibility in respect to an undisclosed Hazardous Environmental Condition is set forth in Paragraph 4.06.

8.11 *Evidence of Financial Arrangements*

A. Upon request of Contractor, Owner shall furnish Contractor reasonable evidence that financial arrangements have been made to satisfy Owner's obligations under the Contract Documents.

8.12 *Compliance with Safety Program*

A. While at the Site, Owner's employees and representatives shall comply with the specific applicable requirements of Contractor's safety programs of which Owner has been informed pursuant to Paragraph 6.13.D.

**ARTICLE 9 – ENGINEER'S STATUS DURING CONSTRUCTION**

9.01 *Owner's Representative*

A. Engineer will be Owner's representative during the construction period. The duties and responsibilities and the limitations of authority of Engineer as Owner's representative during construction are set forth in the Contract Documents.

9.02 *Visits to Site*

A. Engineer will make visits to the Site at intervals appropriate to the various stages of construction as Engineer deems necessary in order to observe as an experienced and qualified design professional the progress that has been made and the quality of the various aspects of Contractor's executed Work. Based on information obtained during such visits and observations, Engineer, for the benefit of Owner, will determine, in general, if the Work is proceeding in accordance with the Contract Documents. Engineer will not be required to make exhaustive or continuous inspections on the Site to check the quality or quantity of the Work. Engineer's efforts will be directed toward providing for Owner a greater degree of confidence that the completed Work will conform generally to the Contract Documents. On the basis of such visits and observations, Engineer will keep Owner informed of the progress of the Work and will endeavor to guard Owner against defective Work.

B. Engineer's visits and observations are subject to all the limitations on Engineer's authority and responsibility set forth in Paragraph 9.09. Particularly, but without limitation, during or as a result of Engineer's visits or observations of Contractor's Work, Engineer will not supervise, direct, control, or have authority over or be responsible for Contractor's means, methods, techniques, sequences, or procedures of construction, or the safety precautions and programs incident thereto, or for any failure of Contractor to comply with Laws and Regulations applicable to the performance of the Work.

9.03 *Project Representative*

- A. If Owner and Engineer agree, Engineer will furnish a Resident Project Representative to assist Engineer in providing more extensive observation of the Work. The authority and responsibilities of any such Resident Project Representative and assistants will be as provided in the Supplementary Conditions, and limitations on the responsibilities thereof will be as provided in Paragraph 9.09. If Owner designates another representative or agent to represent Owner at the Site who is not Engineer's consultant, agent or employee, the responsibilities and authority and limitations thereon of such other individual or entity will be as provided in the Supplementary Conditions.

9.04 *Authorized Variations in Work*

- A. Engineer may authorize minor variations in the Work from the requirements of the Contract Documents which do not involve an adjustment in the Contract Price or the Contract Times and are compatible with the design concept of the completed Project as a functioning whole as indicated by the Contract Documents. These may be accomplished by a Field Order and will be binding on Owner and also on Contractor, who shall perform the Work involved promptly. If Owner or Contractor believes that a Field Order justifies an adjustment in the Contract Price or Contract Times, or both, and the parties are unable to agree on entitlement to or on the amount or extent, if any, of any such adjustment, a Claim may be made therefor as provided in Paragraph 10.05.

9.05 *Rejecting Defective Work*

- A. Engineer will have authority to reject Work which Engineer believes to be defective, or that Engineer believes will not produce a completed Project that conforms to the Contract Documents or that will prejudice the integrity of the design concept of the completed Project as a functioning whole as indicated by the Contract Documents. Engineer will also have authority to require special inspection or testing of the Work as provided in Paragraph 13.04, whether or not the Work is fabricated, installed, or completed.

9.06 *Shop Drawings, Change Orders and Payments*

- A. In connection with Engineer's authority, and limitations thereof, as to Shop Drawings and Samples, see Paragraph 6.17.
- B. In connection with Engineer's authority, and limitations thereof, as to design calculations and design drawings submitted in response to a delegation of professional design services, if any, see Paragraph 6.21.
- C. In connection with Engineer's authority as to Change Orders, see Articles 10, 11, and 12.
- D. In connection with Engineer's authority as to Applications for Payment, see Article 14.

9.07 *Determinations for Unit Price Work*

- A. Engineer will determine the actual quantities and classifications of Unit Price Work performed by Contractor. Engineer will review with Contractor the Engineer's preliminary determinations

on such matters before rendering a written decision thereon (by recommendation of an Application for Payment or otherwise). Engineer's written decision thereon will be final and binding (except as modified by Engineer to reflect changed factual conditions or more accurate data) upon Owner and Contractor, subject to the provisions of Paragraph 10.05.

9.08 *Decisions on Requirements of Contract Documents and Acceptability of Work*

- A. Engineer will be the initial interpreter of the requirements of the Contract Documents and judge of the acceptability of the Work thereunder. All matters in question and other matters between Owner and Contractor arising prior to the date final payment is due relating to the acceptability of the Work, and the interpretation of the requirements of the Contract Documents pertaining to the performance of the Work, will be referred initially to Engineer in writing within 30 days of the event giving rise to the question.
- B. Engineer will, with reasonable promptness, render a written decision on the issue referred. If Owner or Contractor believes that any such decision entitles them to an adjustment in the Contract Price or Contract Times or both, a Claim may be made under Paragraph 10.05. The date of Engineer's decision shall be the date of the event giving rise to the issues referenced for the purposes of Paragraph 10.05.B.
- C. Engineer's written decision on the issue referred will be final and binding on Owner and Contractor, subject to the provisions of Paragraph 10.05.
- D. When functioning as interpreter and judge under this Paragraph 9.08, Engineer will not show partiality to Owner or Contractor and will not be liable in connection with any interpretation or decision rendered in good faith in such capacity.

9.09 *Limitations on Engineer's Authority and Responsibilities*

- A. Neither Engineer's authority or responsibility under this Article 9 or under any other provision of the Contract Documents nor any decision made by Engineer in good faith either to exercise or not exercise such authority or responsibility or the undertaking, exercise, or performance of any authority or responsibility by Engineer shall create, impose, or give rise to any duty in contract, tort, or otherwise owed by Engineer to Contractor, any Subcontractor, any Supplier, any other individual or entity, or to any surety for or employee or agent of any of them.
- B. Engineer will not supervise, direct, control, or have authority over or be responsible for Contractor's means, methods, techniques, sequences, or procedures of construction, or the safety precautions and programs incident thereto, or for any failure of Contractor to comply with Laws and Regulations applicable to the performance of the Work. Engineer will not be responsible for Contractor's failure to perform the Work in accordance with the Contract Documents.
- C. Engineer will not be responsible for the acts or omissions of Contractor or of any Subcontractor, any Supplier, or of any other individual or entity performing any of the Work.
- D. Engineer's review of the final Application for Payment and accompanying documentation and all maintenance and operating instructions, schedules, guarantees, bonds, certificates of inspection, tests and approvals, and other documentation required to be delivered by Paragraph 14.07.A will only be to determine generally that their content complies with the requirements of,



and in the case of certificates of inspections, tests, and approvals that the results certified indicate compliance with, the Contract Documents.

- E. The limitations upon authority and responsibility set forth in this Paragraph 9.09 shall also apply to the Resident Project Representative, if any, and assistants, if any.

#### 9.10 *Compliance with Safety Program*

- A. While at the Site, Engineer's employees and representatives shall comply with the specific applicable requirements of Contractor's safety programs of which Engineer has been informed pursuant to Paragraph 6.13.D.

### **ARTICLE 10 – CHANGES IN THE WORK; CLAIMS**

#### 10.01 *Authorized Changes in the Work*

- A. Without invalidating the Contract and without notice to any surety, Owner may, at any time or from time to time, order additions, deletions, or revisions in the Work by a Change Order, or a Work Change Directive. Upon receipt of any such document, Contractor shall promptly proceed with the Work involved which will be performed under the applicable conditions of the Contract Documents (except as otherwise specifically provided).
- B. If Owner and Contractor are unable to agree on entitlement to, or on the amount or extent, if any, of an adjustment in the Contract Price or Contract Times, or both, that should be allowed as a result of a Work Change Directive, a Claim may be made therefor as provided in Paragraph 10.05.

#### 10.02 *Unauthorized Changes in the Work*

- A. Contractor shall not be entitled to an increase in the Contract Price or an extension of the Contract Times with respect to any work performed that is not required by the Contract Documents as amended, modified, or supplemented as provided in Paragraph 3.04, except in the case of an emergency as provided in Paragraph 6.16 or in the case of uncovering Work as provided in Paragraph 13.04.D.

#### 10.03 *Execution of Change Orders*

- A. Owner and Contractor shall execute appropriate Change Orders recommended by Engineer covering:
  - 1. changes in the Work which are: (i) ordered by Owner pursuant to Paragraph 10.01.A, (ii) required because of acceptance of defective Work under Paragraph 13.08.A or Owner's correction of defective Work under Paragraph 13.09, or (iii) agreed to by the parties;
  - 2. changes in the Contract Price or Contract Times which are agreed to by the parties, including any undisputed sum or amount of time for Work actually performed in accordance with a Work Change Directive; and
  - 3. changes in the Contract Price or Contract Times which embody the substance of any written decision rendered by Engineer pursuant to Paragraph 10.05; provided that, in lieu of

executing any such Change Order, an appeal may be taken from any such decision in accordance with the provisions of the Contract Documents and applicable Laws and Regulations, but during any such appeal, Contractor shall carry on the Work and adhere to the Progress Schedule as provided in Paragraph 6.18.A.

#### 10.04 *Notification to Surety*

- A. If the provisions of any bond require notice to be given to a surety of any change affecting the general scope of the Work or the provisions of the Contract Documents (including, but not limited to, Contract Price or Contract Times), the giving of any such notice will be Contractor's responsibility. The amount of each applicable bond will be adjusted to reflect the effect of any such change.

#### 10.05 *Claims*

- A. *Engineer's Decision Required:* All Claims, except those waived pursuant to Paragraph 14.09, shall be referred to the Engineer for decision. A decision by Engineer shall be required as a condition precedent to any exercise by Owner or Contractor of any rights or remedies either may otherwise have under the Contract Documents or by Laws and Regulations in respect of such Claims.
- B. *Notice:* Written notice stating the general nature of each Claim shall be delivered by the claimant to Engineer and the other party to the Contract promptly (but in no event later than 30 days) after the start of the event giving rise thereto. The responsibility to substantiate a Claim shall rest with the party making the Claim. Notice of the amount or extent of the Claim, with supporting data shall be delivered to the Engineer and the other party to the Contract within 60 days after the start of such event (unless Engineer allows additional time for claimant to submit additional or more accurate data in support of such Claim). A Claim for an adjustment in Contract Price shall be prepared in accordance with the provisions of Paragraph 12.01.B. A Claim for an adjustment in Contract Times shall be prepared in accordance with the provisions of Paragraph 12.02.B. Each Claim shall be accompanied by claimant's written statement that the adjustment claimed is the entire adjustment to which the claimant believes it is entitled as a result of said event. The opposing party shall submit any response to Engineer and the claimant within 30 days after receipt of the claimant's last submittal (unless Engineer allows additional time).
- C. *Engineer's Action:* Engineer will review each Claim and, within 30 days after receipt of the last submittal of the claimant or the last submittal of the opposing party, if any, take one of the following actions in writing:
1. deny the Claim in whole or in part;
  2. approve the Claim; or
  3. notify the parties that the Engineer is unable to resolve the Claim if, in the Engineer's sole discretion, it would be inappropriate for the Engineer to do so. For purposes of further resolution of the Claim, such notice shall be deemed a denial.
- D. In the event that Engineer does not take action on a Claim within said 30 days, the Claim shall be deemed denied.

- E. Engineer's written action under Paragraph 10.05.C or denial pursuant to Paragraphs 10.05.C.3 or 10.05.D will be final and binding upon Owner and Contractor, unless Owner or Contractor invoke the dispute resolution procedure set forth in Article 16 within 30 days of such action or denial.
- F. No Claim for an adjustment in Contract Price or Contract Times will be valid if not submitted in accordance with this Paragraph 10.05.

## **ARTICLE 11 – COST OF THE WORK; ALLOWANCES; UNIT PRICE WORK**

### *11.01 Cost of the Work*

- A. *Costs Included:* The term Cost of the Work means the sum of all costs, except those excluded in Paragraph 11.01.B, necessarily incurred and paid by Contractor in the proper performance of the Work. When the value of any Work covered by a Change Order or when a Claim for an adjustment in Contract Price is determined on the basis of Cost of the Work, the costs to be reimbursed to Contractor will be only those additional or incremental costs required because of the change in the Work or because of the event giving rise to the Claim. Except as otherwise may be agreed to in writing by Owner, such costs shall be in amounts no higher than those prevailing in the locality of the Project, shall not include any of the costs itemized in Paragraph 11.01.B, and shall include only the following items:
  - 1. Payroll costs for employees in the direct employ of Contractor in the performance of the Work under schedules of job classifications agreed upon by Owner and Contractor. Such employees shall include, without limitation, superintendents, foremen, and other personnel employed full time on the Work. Payroll costs for employees not employed full time on the Work shall be apportioned on the basis of their time spent on the Work. Payroll costs shall include, but not be limited to, salaries and wages plus the cost of fringe benefits, which shall include social security contributions, unemployment, excise, and payroll taxes, workers' compensation, health and retirement benefits, bonuses, sick leave, vacation and holiday pay applicable thereto. The expenses of performing Work outside of regular working hours, on Saturday, Sunday, or legal holidays, shall be included in the above to the extent authorized by Owner.
  - 2. Cost of all materials and equipment furnished and incorporated in the Work, including costs of transportation and storage thereof, and Suppliers' field services required in connection therewith. All cash discounts shall accrue to Contractor unless Owner deposits funds with Contractor with which to make payments, in which case the cash discounts shall accrue to Owner. All trade discounts, rebates and refunds and returns from sale of surplus materials and equipment shall accrue to Owner, and Contractor shall make provisions so that they may be obtained.
  - 3. Payments made by Contractor to Subcontractors for Work performed by Subcontractors. If required by Owner, Contractor shall obtain competitive bids from subcontractors acceptable to Owner and Contractor and shall deliver such bids to Owner, who will then determine, with the advice of Engineer, which bids, if any, will be acceptable. If any subcontract provides that the Subcontractor is to be paid on the basis of Cost of the Work plus a fee, the Subcontractor's Cost of the Work and fee shall be determined in the same manner as Contractor's Cost of the Work and fee as provided in this Paragraph 11.01.

4. Costs of special consultants (including but not limited to engineers, architects, testing laboratories, surveyors, attorneys, and accountants) employed for services specifically related to the Work.
5. Supplemental costs including the following:
  - a. The proportion of necessary transportation, travel, and subsistence expenses of Contractor's employees incurred in discharge of duties connected with the Work.
  - b. Cost, including transportation and maintenance, of all materials, supplies, equipment, machinery, appliances, office, and temporary facilities at the Site, and hand tools not owned by the workers, which are consumed in the performance of the Work, and cost, less market value, of such items used but not consumed which remain the property of Contractor.
  - c. Rentals of all construction equipment and machinery, and the parts thereof whether rented from Contractor or others in accordance with rental agreements approved by Owner with the advice of Engineer, and the costs of transportation, loading, unloading, assembly, dismantling, and removal thereof. All such costs shall be in accordance with the terms of said rental agreements. The rental of any such equipment, machinery, or parts shall cease when the use thereof is no longer necessary for the Work.
  - d. Sales, consumer, use, and other similar taxes related to the Work, and for which Contractor is liable, as imposed by Laws and Regulations.
  - e. Deposits lost for causes other than negligence of Contractor, any Subcontractor, or anyone directly or indirectly employed by any of them or for whose acts any of them may be liable, and royalty payments and fees for permits and licenses.
  - f. Losses and damages (and related expenses) caused by damage to the Work, not compensated by insurance or otherwise, sustained by Contractor in connection with the performance of the Work (except losses and damages within the deductible amounts of property insurance established in accordance with Paragraph 5.06.D), provided such losses and damages have resulted from causes other than the negligence of Contractor, any Subcontractor, or anyone directly or indirectly employed by any of them or for whose acts any of them may be liable. Such losses shall include settlements made with the written consent and approval of Owner. No such losses, damages, and expenses shall be included in the Cost of the Work for the purpose of determining Contractor's fee.
  - g. The cost of utilities, fuel, and sanitary facilities at the Site.
  - h. Minor expenses such as telegrams, long distance telephone calls, telephone service at the Site, express and courier services, and similar petty cash items in connection with the Work.
  - i. The costs of premiums for all bonds and insurance Contractor is required by the Contract Documents to purchase and maintain.

B. *Costs Excluded:* The term Cost of the Work shall not include any of the following items:

1. Payroll costs and other compensation of Contractor's officers, executives, principals (of partnerships and sole proprietorships), general managers, safety managers, engineers, architects, estimators, attorneys, auditors, accountants, purchasing and contracting agents, expeditors, timekeepers, clerks, and other personnel employed by Contractor, whether at the Site or in Contractor's principal or branch office for general administration of the Work and not specifically included in the agreed upon schedule of job classifications referred to in Paragraph 11.01.A.1 or specifically covered by Paragraph 11.01.A.4, all of which are to be considered administrative costs covered by the Contractor's fee.
  2. Expenses of Contractor's principal and branch offices other than Contractor's office at the Site.
  3. Any part of Contractor's capital expenses, including interest on Contractor's capital employed for the Work and charges against Contractor for delinquent payments.
  4. Costs due to the negligence of Contractor, any Subcontractor, or anyone directly or indirectly employed by any of them or for whose acts any of them may be liable, including but not limited to, the correction of defective Work, disposal of materials or equipment wrongly supplied, and making good any damage to property.
  5. Other overhead or general expense costs of any kind and the costs of any item not specifically and expressly included in Paragraphs 11.01.A.
- C. *Contractor's Fee:* When all the Work is performed on the basis of cost-plus, Contractor's fee shall be determined as set forth in the Agreement. When the value of any Work covered by a Change Order or when a Claim for an adjustment in Contract Price is determined on the basis of Cost of the Work, Contractor's fee shall be determined as set forth in Paragraph 12.01.C.
- D. *Documentation:* Whenever the Cost of the Work for any purpose is to be determined pursuant to Paragraphs 11.01.A and 11.01.B, Contractor will establish and maintain records thereof in accordance with generally accepted accounting practices and submit in a form acceptable to Engineer an itemized cost breakdown together with supporting data.

## 11.02 Allowances

- A. It is understood that Contractor has included in the Contract Price all allowances so named in the Contract Documents and shall cause the Work so covered to be performed for such sums and by such persons or entities as may be acceptable to Owner and Engineer.
- B. *Cash Allowances:*
1. Contractor agrees that:
    - a. the cash allowances include the cost to Contractor (less any applicable trade discounts) of materials and equipment required by the allowances to be delivered at the Site, and all applicable taxes; and
    - b. Contractor's costs for unloading and handling on the Site, labor, installation, overhead, profit, and other expenses contemplated for the cash allowances have been included in

the Contract Price and not in the allowances, and no demand for additional payment on account of any of the foregoing will be valid.

C. *Contingency Allowance:*

1. Contractor agrees that a contingency allowance, if any, is for the sole use of Owner to cover unanticipated costs.
- D. Prior to final payment, an appropriate Change Order will be issued as recommended by Engineer to reflect actual amounts due Contractor on account of Work covered by allowances, and the Contract Price shall be correspondingly adjusted.

11.03 *Unit Price Work*

- A. Where the Contract Documents provide that all or part of the Work is to be Unit Price Work, initially the Contract Price will be deemed to include for all Unit Price Work an amount equal to the sum of the unit price for each separately identified item of Unit Price Work times the estimated quantity of each item as indicated in the Agreement.
- B. The estimated quantities of items of Unit Price Work are not guaranteed and are solely for the purpose of comparison of Bids and determining an initial Contract Price. Determinations of the actual quantities and classifications of Unit Price Work performed by Contractor will be made by Engineer subject to the provisions of Paragraph 9.07.
- C. Each unit price will be deemed to include an amount considered by Contractor to be adequate to cover Contractor's overhead and profit for each separately identified item.
- D. Owner or Contractor may make a Claim for an adjustment in the Contract Price in accordance with Paragraph 10.05 if:
  1. the quantity of any item of Unit Price Work performed by Contractor differs materially and significantly from the estimated quantity of such item indicated in the Agreement; and
  2. there is no corresponding adjustment with respect to any other item of Work; and
  3. Contractor believes that Contractor is entitled to an increase in Contract Price as a result of having incurred additional expense or Owner believes that Owner is entitled to a decrease in Contract Price and the parties are unable to agree as to the amount of any such increase or decrease.

**ARTICLE 12 – CHANGE OF CONTRACT PRICE; CHANGE OF CONTRACT TIMES**

12.01 *Change of Contract Price*

- A. The Contract Price may only be changed by a Change Order. Any Claim for an adjustment in the Contract Price shall be based on written notice submitted by the party making the Claim to the Engineer and the other party to the Contract in accordance with the provisions of Paragraph 10.05.

- B. The value of any Work covered by a Change Order or of any Claim for an adjustment in the Contract Price will be determined as follows:
1. where the Work involved is covered by unit prices contained in the Contract Documents, by application of such unit prices to the quantities of the items involved (subject to the provisions of Paragraph 11.03); or
  2. where the Work involved is not covered by unit prices contained in the Contract Documents, by a mutually agreed lump sum (which may include an allowance for overhead and profit not necessarily in accordance with Paragraph 12.01.C.2); or
  3. where the Work involved is not covered by unit prices contained in the Contract Documents and agreement to a lump sum is not reached under Paragraph 12.01.B.2, on the basis of the Cost of the Work (determined as provided in Paragraph 11.01) plus a Contractor's fee for overhead and profit (determined as provided in Paragraph 12.01.C).
- C. *Contractor's Fee*: The Contractor's fee for overhead and profit shall be determined as follows:
1. a mutually acceptable fixed fee; or
  2. if a fixed fee is not agreed upon, then a fee based on the following percentages of the various portions of the Cost of the Work:
    - a. for costs incurred under Paragraphs 11.01.A.1 and 11.01.A.2, the Contractor's fee shall be 15 percent;
    - b. for costs incurred under Paragraph 11.01.A.3, the Contractor's fee shall be five percent;
    - c. where one or more tiers of subcontracts are on the basis of Cost of the Work plus a fee and no fixed fee is agreed upon, the intent of Paragraphs 12.01.C.2.a and 12.01.C.2.b is that the Subcontractor who actually performs the Work, at whatever tier, will be paid a fee of 15 percent of the costs incurred by such Subcontractor under Paragraphs 11.01.A.1 and 11.01.A.2 and that any higher tier Subcontractor and Contractor will each be paid a fee of five percent of the amount paid to the next lower tier Subcontractor;
    - d. no fee shall be payable on the basis of costs itemized under Paragraphs 11.01.A.4, 11.01.A.5, and 11.01.B;
    - e. the amount of credit to be allowed by Contractor to Owner for any change which results in a net decrease in cost will be the amount of the actual net decrease in cost plus a deduction in Contractor's fee by an amount equal to five percent of such net decrease; and
    - f. when both additions and credits are involved in any one change, the adjustment in Contractor's fee shall be computed on the basis of the net change in accordance with Paragraphs 12.01.C.2.a through 12.01.C.2.e, inclusive.

## 12.02 *Change of Contract Times*

- A. The Contract Times may only be changed by a Change Order. Any Claim for an adjustment in the Contract Times shall be based on written notice submitted by the party making the Claim to the Engineer and the other party to the Contract in accordance with the provisions of Paragraph 10.05.
- B. Any adjustment of the Contract Times covered by a Change Order or any Claim for an adjustment in the Contract Times will be determined in accordance with the provisions of this Article 12.

## 12.03 *Delays*

- A. Where Contractor is prevented from completing any part of the Work within the Contract Times due to delay beyond the control of Contractor, the Contract Times will be extended in an amount equal to the time lost due to such delay if a Claim is made therefor as provided in Paragraph 12.02.A. Delays beyond the control of Contractor shall include, but not be limited to, acts or neglect by Owner, acts or neglect of utility owners or other contractors performing other work as contemplated by Article 7, fires, floods, epidemics, abnormal weather conditions, or acts of God.
- B. If Owner, Engineer, or other contractors or utility owners performing other work for Owner as contemplated by Article 7, or anyone for whom Owner is responsible, delays, disrupts, or interferes with the performance or progress of the Work, then Contractor shall be entitled to an equitable adjustment in the Contract Price or the Contract Times, or both. Contractor's entitlement to an adjustment of the Contract Times is conditioned on such adjustment being essential to Contractor's ability to complete the Work within the Contract Times.
- C. If Contractor is delayed in the performance or progress of the Work by fire, flood, epidemic, abnormal weather conditions, acts of God, acts or failures to act of utility owners not under the control of Owner, or other causes not the fault of and beyond control of Owner and Contractor, then Contractor shall be entitled to an equitable adjustment in Contract Times, if such adjustment is essential to Contractor's ability to complete the Work within the Contract Times. Such an adjustment shall be Contractor's sole and exclusive remedy for the delays described in this Paragraph 12.03.C.
- D. Owner, Engineer, and their officers, directors, members, partners, employees, agents, consultants, or subcontractors shall not be liable to Contractor for any claims, costs, losses, or damages (including but not limited to all fees and charges of engineers, architects, attorneys, and other professionals and all court or arbitration or other dispute resolution costs) sustained by Contractor on or in connection with any other project or anticipated project.
- E. Contractor shall not be entitled to an adjustment in Contract Price or Contract Times for delays within the control of Contractor. Delays attributable to and within the control of a Subcontractor or Supplier shall be deemed to be delays within the control of Contractor.



**ARTICLE 13 – TESTS AND INSPECTIONS; CORRECTION, REMOVAL OR ACCEPTANCE OF DEFECTIVE WORK**

13.01 *Notice of Defects*

- A. Prompt notice of all defective Work of which Owner or Engineer has actual knowledge will be given to Contractor. Defective Work may be rejected, corrected, or accepted as provided in this Article 13.

13.02 *Access to Work*

- A. Owner, Engineer, their consultants and other representatives and personnel of Owner, independent testing laboratories, and governmental agencies with jurisdictional interests will have access to the Site and the Work at reasonable times for their observation, inspection, and testing. Contractor shall provide them proper and safe conditions for such access and advise them of Contractor's safety procedures and programs so that they may comply therewith as applicable.

13.03 *Tests and Inspections*

- A. Contractor shall give Engineer timely notice of readiness of the Work for all required inspections, tests, or approvals and shall cooperate with inspection and testing personnel to facilitate required inspections or tests.
- B. Owner shall employ and pay for the services of an independent testing laboratory to perform all inspections, tests, or approvals required by the Contract Documents except:
  - 1. for inspections, tests, or approvals covered by Paragraphs 13.03.C and 13.03.D below;
  - 2. that costs incurred in connection with tests or inspections conducted pursuant to Paragraph 13.04.B shall be paid as provided in Paragraph 13.04.C; and
  - 3. as otherwise specifically provided in the Contract Documents.
- C. If Laws or Regulations of any public body having jurisdiction require any Work (or part thereof) specifically to be inspected, tested, or approved by an employee or other representative of such public body, Contractor shall assume full responsibility for arranging and obtaining such inspections, tests, or approvals, pay all costs in connection therewith, and furnish Engineer the required certificates of inspection or approval.
- D. Contractor shall be responsible for arranging and obtaining and shall pay all costs in connection with any inspections, tests, or approvals required for Owner's and Engineer's acceptance of materials or equipment to be incorporated in the Work; or acceptance of materials, mix designs, or equipment submitted for approval prior to Contractor's purchase thereof for incorporation in the Work. Such inspections, tests, or approvals shall be performed by organizations acceptable to Owner and Engineer.

- E. If any Work (or the work of others) that is to be inspected, tested, or approved is covered by Contractor without written concurrence of Engineer, Contractor shall, if requested by Engineer, uncover such Work for observation.
- F. Uncovering Work as provided in Paragraph 13.03.E shall be at Contractor's expense unless Contractor has given Engineer timely notice of Contractor's intention to cover the same and Engineer has not acted with reasonable promptness in response to such notice.

#### 13.04 *Uncovering Work*

- A. If any Work is covered contrary to the written request of Engineer, it must, if requested by Engineer, be uncovered for Engineer's observation and replaced at Contractor's expense.
- B. If Engineer considers it necessary or advisable that covered Work be observed by Engineer or inspected or tested by others, Contractor, at Engineer's request, shall uncover, expose, or otherwise make available for observation, inspection, or testing as Engineer may require, that portion of the Work in question, furnishing all necessary labor, material, and equipment.
- C. If it is found that the uncovered Work is defective, Contractor shall pay all claims, costs, losses, and damages (including but not limited to all fees and charges of engineers, architects, attorneys, and other professionals and all court or arbitration or other dispute resolution costs) arising out of or relating to such uncovering, exposure, observation, inspection, and testing, and of satisfactory replacement or reconstruction (including but not limited to all costs of repair or replacement of work of others); and Owner shall be entitled to an appropriate decrease in the Contract Price. If the parties are unable to agree as to the amount thereof, Owner may make a Claim therefor as provided in Paragraph 10.05.
- D. If the uncovered Work is not found to be defective, Contractor shall be allowed an increase in the Contract Price or an extension of the Contract Times, or both, directly attributable to such uncovering, exposure, observation, inspection, testing, replacement, and reconstruction. If the parties are unable to agree as to the amount or extent thereof, Contractor may make a Claim therefor as provided in Paragraph 10.05.

#### 13.05 *Owner May Stop the Work*

- A. If the Work is defective, or Contractor fails to supply sufficient skilled workers or suitable materials or equipment, or fails to perform the Work in such a way that the completed Work will conform to the Contract Documents, Owner may order Contractor to stop the Work, or any portion thereof, until the cause for such order has been eliminated; however, this right of Owner to stop the Work shall not give rise to any duty on the part of Owner to exercise this right for the benefit of Contractor, any Subcontractor, any Supplier, any other individual or entity, or any surety for, or employee or agent of any of them.

#### 13.06 *Correction or Removal of Defective Work*

- A. Promptly after receipt of written notice, Contractor shall correct all defective Work, whether or not fabricated, installed, or completed, or, if the Work has been rejected by Engineer, remove it from the Project and replace it with Work that is not defective. Contractor shall pay all claims, costs, losses, and damages (including but not limited to all fees and charges of engineers,

architects, attorneys, and other professionals and all court or arbitration or other dispute resolution costs) arising out of or relating to such correction or removal (including but not limited to all costs of repair or replacement of work of others).

- B. When correcting defective Work under the terms of this Paragraph 13.06 or Paragraph 13.07, Contractor shall take no action that would void or otherwise impair Owner's special warranty and guarantee, if any, on said Work.

### 13.07 *Correction Period*

- A. If within one year after the date of Substantial Completion (or such longer period of time as may be prescribed by the terms of any applicable special guarantee required by the Contract Documents) or by any specific provision of the Contract Documents, any Work is found to be defective, or if the repair of any damages to the land or areas made available for Contractor's use by Owner or permitted by Laws and Regulations as contemplated in Paragraph 6.11.A is found to be defective, Contractor shall promptly, without cost to Owner and in accordance with Owner's written instructions:
1. repair such defective land or areas; or
  2. correct such defective Work; or
  3. if the defective Work has been rejected by Owner, remove it from the Project and replace it with Work that is not defective, and
  4. satisfactorily correct or repair or remove and replace any damage to other Work, to the work of others or other land or areas resulting therefrom.
- B. If Contractor does not promptly comply with the terms of Owner's written instructions, or in an emergency where delay would cause serious risk of loss or damage, Owner may have the defective Work corrected or repaired or may have the rejected Work removed and replaced. All claims, costs, losses, and damages (including but not limited to all fees and charges of engineers, architects, attorneys, and other professionals and all court or arbitration or other dispute resolution costs) arising out of or relating to such correction or repair or such removal and replacement (including but not limited to all costs of repair or replacement of work of others) will be paid by Contractor.
- C. In special circumstances where a particular item of equipment is placed in continuous service before Substantial Completion of all the Work, the correction period for that item may start to run from an earlier date if so provided in the Specifications.
- D. Where defective Work (and damage to other Work resulting therefrom) has been corrected or removed and replaced under this Paragraph 13.07, the correction period hereunder with respect to such Work will be extended for an additional period of one year after such correction or removal and replacement has been satisfactorily completed.
- E. Contractor's obligations under this Paragraph 13.07 are in addition to any other obligation or warranty. The provisions of this Paragraph 13.07 shall not be construed as a substitute for, or a waiver of, the provisions of any applicable statute of limitation or repose.

### 13.08 *Acceptance of Defective Work*

- A. If, instead of requiring correction or removal and replacement of defective Work, Owner (and, prior to Engineer's recommendation of final payment, Engineer) prefers to accept it, Owner may do so. Contractor shall pay all claims, costs, losses, and damages (including but not limited to all fees and charges of engineers, architects, attorneys, and other professionals and all court or arbitration or other dispute resolution costs) attributable to Owner's evaluation of and determination to accept such defective Work (such costs to be approved by Engineer as to reasonableness) and for the diminished value of the Work to the extent not otherwise paid by Contractor pursuant to this sentence. If any such acceptance occurs prior to Engineer's recommendation of final payment, a Change Order will be issued incorporating the necessary revisions in the Contract Documents with respect to the Work, and Owner shall be entitled to an appropriate decrease in the Contract Price, reflecting the diminished value of Work so accepted. If the parties are unable to agree as to the amount thereof, Owner may make a Claim therefor as provided in Paragraph 10.05. If the acceptance occurs after such recommendation, an appropriate amount will be paid by Contractor to Owner.

### 13.09 *Owner May Correct Defective Work*

- A. If Contractor fails within a reasonable time after written notice from Engineer to correct defective Work, or to remove and replace rejected Work as required by Engineer in accordance with Paragraph 13.06.A, or if Contractor fails to perform the Work in accordance with the Contract Documents, or if Contractor fails to comply with any other provision of the Contract Documents, Owner may, after seven days written notice to Contractor, correct, or remedy any such deficiency.
- B. In exercising the rights and remedies under this Paragraph 13.09, Owner shall proceed expeditiously. In connection with such corrective or remedial action, Owner may exclude Contractor from all or part of the Site, take possession of all or part of the Work and suspend Contractor's services related thereto, take possession of Contractor's tools, appliances, construction equipment and machinery at the Site, and incorporate in the Work all materials and equipment stored at the Site or for which Owner has paid Contractor but which are stored elsewhere. Contractor shall allow Owner, Owner's representatives, agents and employees, Owner's other contractors, and Engineer and Engineer's consultants access to the Site to enable Owner to exercise the rights and remedies under this Paragraph.
- C. All claims, costs, losses, and damages (including but not limited to all fees and charges of engineers, architects, attorneys, and other professionals and all court or arbitration or other dispute resolution costs) incurred or sustained by Owner in exercising the rights and remedies under this Paragraph 13.09 will be charged against Contractor, and a Change Order will be issued incorporating the necessary revisions in the Contract Documents with respect to the Work; and Owner shall be entitled to an appropriate decrease in the Contract Price. If the parties are unable to agree as to the amount of the adjustment, Owner may make a Claim therefor as provided in Paragraph 10.05. Such claims, costs, losses and damages will include but not be limited to all costs of repair, or replacement of work of others destroyed or damaged by correction, removal, or replacement of Contractor's defective Work.

- D. Contractor shall not be allowed an extension of the Contract Times because of any delay in the performance of the Work attributable to the exercise by Owner of Owner's rights and remedies under this Paragraph 13.09.

## **ARTICLE 14 – PAYMENTS TO CONTRACTOR AND COMPLETION**

### *14.01 Schedule of Values*

- A. The Schedule of Values established as provided in Paragraph 2.07.A will serve as the basis for progress payments and will be incorporated into a form of Application for Payment acceptable to Engineer. Progress payments on account of Unit Price Work will be based on the number of units completed.

### *14.02 Progress Payments*

#### *A. Applications for Payments:*

1. At least 20 days before the date established in the Agreement for each progress payment (but not more often than once a month), Contractor shall submit to Engineer for review an Application for Payment filled out and signed by Contractor covering the Work completed as of the date of the Application and accompanied by such supporting documentation as is required by the Contract Documents. If payment is requested on the basis of materials and equipment not incorporated in the Work but delivered and suitably stored at the Site or at another location agreed to in writing, the Application for Payment shall also be accompanied by a bill of sale, invoice, or other documentation warranting that Owner has received the materials and equipment free and clear of all Liens and evidence that the materials and equipment are covered by appropriate property insurance or other arrangements to protect Owner's interest therein, all of which must be satisfactory to Owner.
2. Beginning with the second Application for Payment, each Application shall include an affidavit of Contractor stating that all previous progress payments received on account of the Work have been applied on account to discharge Contractor's legitimate obligations associated with prior Applications for Payment.
3. The amount of retainage with respect to progress payments will be as stipulated in the Agreement.

#### *B. Review of Applications:*

1. Engineer will, within 10 days after receipt of each Application for Payment, either indicate in writing a recommendation of payment and present the Application to Owner or return the Application to Contractor indicating in writing Engineer's reasons for refusing to recommend payment. In the latter case, Contractor may make the necessary corrections and resubmit the Application.
2. Engineer's recommendation of any payment requested in an Application for Payment will constitute a representation by Engineer to Owner, based on Engineer's observations of the executed Work as an experienced and qualified design professional, and on Engineer's

review of the Application for Payment and the accompanying data and schedules, that to the best of Engineer's knowledge, information and belief:

- a. the Work has progressed to the point indicated;
  - b. the quality of the Work is generally in accordance with the Contract Documents (subject to an evaluation of the Work as a functioning whole prior to or upon Substantial Completion, the results of any subsequent tests called for in the Contract Documents, a final determination of quantities and classifications for Unit Price Work under Paragraph 9.07, and any other qualifications stated in the recommendation); and
  - c. the conditions precedent to Contractor's being entitled to such payment appear to have been fulfilled in so far as it is Engineer's responsibility to observe the Work.
3. By recommending any such payment Engineer will not thereby be deemed to have represented that:
- a. inspections made to check the quality or the quantity of the Work as it has been performed have been exhaustive, extended to every aspect of the Work in progress, or involved detailed inspections of the Work beyond the responsibilities specifically assigned to Engineer in the Contract Documents; or
  - b. there may not be other matters or issues between the parties that might entitle Contractor to be paid additionally by Owner or entitle Owner to withhold payment to Contractor.
4. Neither Engineer's review of Contractor's Work for the purposes of recommending payments nor Engineer's recommendation of any payment, including final payment, will impose responsibility on Engineer:
- a. to supervise, direct, or control the Work, or
  - b. for the means, methods, techniques, sequences, or procedures of construction, or the safety precautions and programs incident thereto, or
  - c. for Contractor's failure to comply with Laws and Regulations applicable to Contractor's performance of the Work, or
  - d. to make any examination to ascertain how or for what purposes Contractor has used the moneys paid on account of the Contract Price, or
  - e. to determine that title to any of the Work, materials, or equipment has passed to Owner free and clear of any Liens.
5. Engineer may refuse to recommend the whole or any part of any payment if, in Engineer's opinion, it would be incorrect to make the representations to Owner stated in Paragraph 14.02.B.2. Engineer may also refuse to recommend any such payment or, because of subsequently discovered evidence or the results of subsequent inspections or tests, revise or revoke any such payment recommendation previously made, to such extent as may be necessary in Engineer's opinion to protect Owner from loss because:

- a. the Work is defective, or completed Work has been damaged, requiring correction or replacement;
- b. the Contract Price has been reduced by Change Orders;
- c. Owner has been required to correct defective Work or complete Work in accordance with Paragraph 13.09; or
- d. Engineer has actual knowledge of the occurrence of any of the events enumerated in Paragraph 15.02.A.

C. *Payment Becomes Due:*

1. Ten days after presentation of the Application for Payment to Owner with Engineer's recommendation, the amount recommended will (subject to the provisions of Paragraph 14.02.D) become due, and when due will be paid by Owner to Contractor.

D. *Reduction in Payment:*

1. Owner may refuse to make payment of the full amount recommended by Engineer because:
  - a. claims have been made against Owner on account of Contractor's performance or furnishing of the Work;
  - b. Liens have been filed in connection with the Work, except where Contractor has delivered a specific bond satisfactory to Owner to secure the satisfaction and discharge of such Liens;
  - c. there are other items entitling Owner to a set-off against the amount recommended; or
  - d. Owner has actual knowledge of the occurrence of any of the events enumerated in Paragraphs 14.02.B.5.a through 14.02.B.5.c or Paragraph 15.02.A.
2. If Owner refuses to make payment of the full amount recommended by Engineer, Owner will give Contractor immediate written notice (with a copy to Engineer) stating the reasons for such action and promptly pay Contractor any amount remaining after deduction of the amount so withheld. Owner shall promptly pay Contractor the amount so withheld, or any adjustment thereto agreed to by Owner and Contractor, when Contractor remedies the reasons for such action.
3. Upon a subsequent determination that Owner's refusal of payment was not justified, the amount wrongfully withheld shall be treated as an amount due as determined by Paragraph 14.02.C.1 and subject to interest as provided in the Agreement.

14.03 *Contractor's Warranty of Title*

- A. Contractor warrants and guarantees that title to all Work, materials, and equipment covered by any Application for Payment, whether incorporated in the Project or not, will pass to Owner no later than the time of payment free and clear of all Liens.

#### 14.04 *Substantial Completion*

- A. When Contractor considers the entire Work ready for its intended use Contractor shall notify Owner and Engineer in writing that the entire Work is substantially complete (except for items specifically listed by Contractor as incomplete) and request that Engineer issue a certificate of Substantial Completion.
- B. Promptly after Contractor's notification, Owner, Contractor, and Engineer shall make an inspection of the Work to determine the status of completion. If Engineer does not consider the Work substantially complete, Engineer will notify Contractor in writing giving the reasons therefor.
- C. If Engineer considers the Work substantially complete, Engineer will deliver to Owner a tentative certificate of Substantial Completion which shall fix the date of Substantial Completion. There shall be attached to the certificate a tentative list of items to be completed or corrected before final payment. Owner shall have seven days after receipt of the tentative certificate during which to make written objection to Engineer as to any provisions of the certificate or attached list. If, after considering such objections, Engineer concludes that the Work is not substantially complete, Engineer will, within 14 days after submission of the tentative certificate to Owner, notify Contractor in writing, stating the reasons therefor. If, after consideration of Owner's objections, Engineer considers the Work substantially complete, Engineer will, within said 14 days, execute and deliver to Owner and Contractor a definitive certificate of Substantial Completion (with a revised tentative list of items to be completed or corrected) reflecting such changes from the tentative certificate as Engineer believes justified after consideration of any objections from Owner.
- D. At the time of delivery of the tentative certificate of Substantial Completion, Engineer will deliver to Owner and Contractor a written recommendation as to division of responsibilities pending final payment between Owner and Contractor with respect to security, operation, safety, and protection of the Work, maintenance, heat, utilities, insurance, and warranties and guarantees. Unless Owner and Contractor agree otherwise in writing and so inform Engineer in writing prior to Engineer's issuing the definitive certificate of Substantial Completion, Engineer's aforesaid recommendation will be binding on Owner and Contractor until final payment.
- E. Owner shall have the right to exclude Contractor from the Site after the date of Substantial Completion subject to allowing Contractor reasonable access to remove its property and complete or correct items on the tentative list.

#### 14.05 *Partial Utilization*

- A. Prior to Substantial Completion of all the Work, Owner may use or occupy any substantially completed part of the Work which has specifically been identified in the Contract Documents, or which Owner, Engineer, and Contractor agree constitutes a separately functioning and usable part of the Work that can be used by Owner for its intended purpose without significant interference with Contractor's performance of the remainder of the Work, subject to the following conditions:



1. Owner at any time may request Contractor in writing to permit Owner to use or occupy any such part of the Work which Owner believes to be ready for its intended use and substantially complete. If and when Contractor agrees that such part of the Work is substantially complete, Contractor, Owner, and Engineer will follow the procedures of Paragraph 14.04.A through D for that part of the Work.
2. Contractor at any time may notify Owner and Engineer in writing that Contractor considers any such part of the Work ready for its intended use and substantially complete and request Engineer to issue a certificate of Substantial Completion for that part of the Work.
3. Within a reasonable time after either such request, Owner, Contractor, and Engineer shall make an inspection of that part of the Work to determine its status of completion. If Engineer does not consider that part of the Work to be substantially complete, Engineer will notify Owner and Contractor in writing giving the reasons therefor. If Engineer considers that part of the Work to be substantially complete, the provisions of Paragraph 14.04 will apply with respect to certification of Substantial Completion of that part of the Work and the division of responsibility in respect thereof and access thereto.
4. No use or occupancy or separate operation of part of the Work may occur prior to compliance with the requirements of Paragraph 5.10 regarding property insurance.

#### 14.06 *Final Inspection*

- A. Upon written notice from Contractor that the entire Work or an agreed portion thereof is complete, Engineer will promptly make a final inspection with Owner and Contractor and will notify Contractor in writing of all particulars in which this inspection reveals that the Work is incomplete or defective. Contractor shall immediately take such measures as are necessary to complete such Work or remedy such deficiencies.

#### 14.07 *Final Payment*

##### A. *Application for Payment:*

1. After Contractor has, in the opinion of Engineer, satisfactorily completed all corrections identified during the final inspection and has delivered, in accordance with the Contract Documents, all maintenance and operating instructions, schedules, guarantees, bonds, certificates or other evidence of insurance, certificates of inspection, marked-up record documents (as provided in Paragraph 6.12), and other documents, Contractor may make application for final payment following the procedure for progress payments.
2. The final Application for Payment shall be accompanied (except as previously delivered) by:
  - a. all documentation called for in the Contract Documents, including but not limited to the evidence of insurance required by Paragraph 5.04.B.6;
  - b. consent of the surety, if any, to final payment;
  - c. a list of all Claims against Owner that Contractor believes are unsettled; and

- d. complete and legally effective releases or waivers (satisfactory to Owner) of all Lien rights arising out of or Liens filed in connection with the Work.
3. In lieu of the releases or waivers of Liens specified in Paragraph 14.07.A.2 and as approved by Owner, Contractor may furnish receipts or releases in full and an affidavit of Contractor that: (i) the releases and receipts include all labor, services, material, and equipment for which a Lien could be filed; and (ii) all payrolls, material and equipment bills, and other indebtedness connected with the Work for which Owner might in any way be responsible, or which might in any way result in liens or other burdens on Owner's property, have been paid or otherwise satisfied. If any Subcontractor or Supplier fails to furnish such a release or receipt in full, Contractor may furnish a bond or other collateral satisfactory to Owner to indemnify Owner against any Lien.

*B. Engineer's Review of Application and Acceptance:*

1. If, on the basis of Engineer's observation of the Work during construction and final inspection, and Engineer's review of the final Application for Payment and accompanying documentation as required by the Contract Documents, Engineer is satisfied that the Work has been completed and Contractor's other obligations under the Contract Documents have been fulfilled, Engineer will, within ten days after receipt of the final Application for Payment, indicate in writing Engineer's recommendation of payment and present the Application for Payment to Owner for payment. At the same time Engineer will also give written notice to Owner and Contractor that the Work is acceptable subject to the provisions of Paragraph 14.09. Otherwise, Engineer will return the Application for Payment to Contractor, indicating in writing the reasons for refusing to recommend final payment, in which case Contractor shall make the necessary corrections and resubmit the Application for Payment.

*C. Payment Becomes Due:*

1. Thirty days after the presentation to Owner of the Application for Payment and accompanying documentation, the amount recommended by Engineer, less any sum Owner is entitled to set off against Engineer's recommendation, including but not limited to liquidated damages, will become due and will be paid by Owner to Contractor.

*14.08 Final Completion Delayed*

- A. If, through no fault of Contractor, final completion of the Work is significantly delayed, and if Engineer so confirms, Owner shall, upon receipt of Contractor's final Application for Payment (for Work fully completed and accepted) and recommendation of Engineer, and without terminating the Contract, make payment of the balance due for that portion of the Work fully completed and accepted. If the remaining balance to be held by Owner for Work not fully completed or corrected is less than the retainage stipulated in the Agreement, and if bonds have been furnished as required in Paragraph 5.01, the written consent of the surety to the payment of the balance due for that portion of the Work fully completed and accepted shall be submitted by Contractor to Engineer with the Application for such payment. Such payment shall be made under the terms and conditions governing final payment, except that it shall not constitute a waiver of Claims.

#### 14.09 *Waiver of Claims*

- A. The making and acceptance of final payment will constitute:
1. a waiver of all Claims by Owner against Contractor, except Claims arising from unsettled Liens, from defective Work appearing after final inspection pursuant to Paragraph 14.06, from failure to comply with the Contract Documents or the terms of any special guarantees specified therein, or from Contractor's continuing obligations under the Contract Documents; and
  2. a waiver of all Claims by Contractor against Owner other than those previously made in accordance with the requirements herein and expressly acknowledged by Owner in writing as still unsettled.

### **ARTICLE 15 – SUSPENSION OF WORK AND TERMINATION**

#### 15.01 *Owner May Suspend Work*

- A. At any time and without cause, Owner may suspend the Work or any portion thereof for a period of not more than 90 consecutive days by notice in writing to Contractor and Engineer which will fix the date on which Work will be resumed. Contractor shall resume the Work on the date so fixed. Contractor shall be granted an adjustment in the Contract Price or an extension of the Contract Times, or both, directly attributable to any such suspension if Contractor makes a Claim therefor as provided in Paragraph 10.05.

#### 15.02 *Owner May Terminate for Cause*

- A. The occurrence of any one or more of the following events will justify termination for cause:
1. Contractor's persistent failure to perform the Work in accordance with the Contract Documents (including, but not limited to, failure to supply sufficient skilled workers or suitable materials or equipment or failure to adhere to the Progress Schedule established under Paragraph 2.07 as adjusted from time to time pursuant to Paragraph 6.04);
  2. Contractor's disregard of Laws or Regulations of any public body having jurisdiction;
  3. Contractor's repeated disregard of the authority of Engineer; or
  4. Contractor's violation in any substantial way of any provisions of the Contract Documents.
- B. If one or more of the events identified in Paragraph 15.02.A occur, Owner may, after giving Contractor (and surety) seven days written notice of its intent to terminate the services of Contractor:
1. exclude Contractor from the Site, and take possession of the Work and of all Contractor's tools, appliances, construction equipment, and machinery at the Site, and use the same to the full extent they could be used by Contractor (without liability to Contractor for trespass or conversion);

2. incorporate in the Work all materials and equipment stored at the Site or for which Owner has paid Contractor but which are stored elsewhere; and
  3. complete the Work as Owner may deem expedient.
- C. If Owner proceeds as provided in Paragraph 15.02.B, Contractor shall not be entitled to receive any further payment until the Work is completed. If the unpaid balance of the Contract Price exceeds all claims, costs, losses, and damages (including but not limited to all fees and charges of engineers, architects, attorneys, and other professionals and all court or arbitration or other dispute resolution costs) sustained by Owner arising out of or relating to completing the Work, such excess will be paid to Contractor. If such claims, costs, losses, and damages exceed such unpaid balance, Contractor shall pay the difference to Owner. Such claims, costs, losses, and damages incurred by Owner will be reviewed by Engineer as to their reasonableness and, when so approved by Engineer, incorporated in a Change Order. When exercising any rights or remedies under this Paragraph, Owner shall not be required to obtain the lowest price for the Work performed.
- D. Notwithstanding Paragraphs 15.02.B and 15.02.C, Contractor's services will not be terminated if Contractor begins within seven days of receipt of notice of intent to terminate to correct its failure to perform and proceeds diligently to cure such failure within no more than 30 days of receipt of said notice.
- E. Where Contractor's services have been so terminated by Owner, the termination will not affect any rights or remedies of Owner against Contractor then existing or which may thereafter accrue. Any retention or payment of moneys due Contractor by Owner will not release Contractor from liability.
- F. If and to the extent that Contractor has provided a performance bond under the provisions of Paragraph 5.01.A, the termination procedures of that bond shall supersede the provisions of Paragraphs 15.02.B and 15.02.C.

### 15.03 *Owner May Terminate For Convenience*

- A. Upon seven days written notice to Contractor and Engineer, Owner may, without cause and without prejudice to any other right or remedy of Owner, terminate the Contract. In such case, Contractor shall be paid for (without duplication of any items):
1. completed and acceptable Work executed in accordance with the Contract Documents prior to the effective date of termination, including fair and reasonable sums for overhead and profit on such Work;
  2. expenses sustained prior to the effective date of termination in performing services and furnishing labor, materials, or equipment as required by the Contract Documents in connection with uncompleted Work, plus fair and reasonable sums for overhead and profit on such expenses;
  3. all claims, costs, losses, and damages (including but not limited to all fees and charges of engineers, architects, attorneys, and other professionals and all court or arbitration or other

dispute resolution costs) incurred in settlement of terminated contracts with Subcontractors, Suppliers, and others; and

4. reasonable expenses directly attributable to termination.

B. Contractor shall not be paid on account of loss of anticipated profits or revenue or other economic loss arising out of or resulting from such termination.

#### 15.04 *Contractor May Stop Work or Terminate*

A. If, through no act or fault of Contractor, (i) the Work is suspended for more than 90 consecutive days by Owner or under an order of court or other public authority, or (ii) Engineer fails to act on any Application for Payment within 30 days after it is submitted, or (iii) Owner fails for 30 days to pay Contractor any sum finally determined to be due, then Contractor may, upon seven days written notice to Owner and Engineer, and provided Owner or Engineer do not remedy such suspension or failure within that time, terminate the Contract and recover from Owner payment on the same terms as provided in Paragraph 15.03.

B. In lieu of terminating the Contract and without prejudice to any other right or remedy, if Engineer has failed to act on an Application for Payment within 30 days after it is submitted, or Owner has failed for 30 days to pay Contractor any sum finally determined to be due, Contractor may, seven days after written notice to Owner and Engineer, stop the Work until payment is made of all such amounts due Contractor, including interest thereon. The provisions of this Paragraph 15.04 are not intended to preclude Contractor from making a Claim under Paragraph 10.05 for an adjustment in Contract Price or Contract Times or otherwise for expenses or damage directly attributable to Contractor's stopping the Work as permitted by this Paragraph.

## **ARTICLE 16 – DISPUTE RESOLUTION**

### 16.01 *Methods and Procedures*

A. Either Owner or Contractor may request mediation of any Claim submitted to Engineer for a decision under Paragraph 10.05 before such decision becomes final and binding. The mediation will be governed by the Construction Industry Mediation Rules of the American Arbitration Association in effect as of the Effective Date of the Agreement. The request for mediation shall be submitted in writing to the American Arbitration Association and the other party to the Contract. Timely submission of the request shall stay the effect of Paragraph 10.05.E.

B. Owner and Contractor shall participate in the mediation process in good faith. The process shall be concluded within 60 days of filing of the request. The date of termination of the mediation shall be determined by application of the mediation rules referenced above.

C. If the Claim is not resolved by mediation, Engineer's action under Paragraph 10.05.C or a denial pursuant to Paragraphs 10.05.C.3 or 10.05.D shall become final and binding 30 days after termination of the mediation unless, within that time period, Owner or Contractor:

1. elects in writing to invoke any dispute resolution process provided for in the Supplementary Conditions; or

2. agrees with the other party to submit the Claim to another dispute resolution process; or
3. gives written notice to the other party of the intent to submit the Claim to a court of competent jurisdiction.

## ARTICLE 17 – MISCELLANEOUS

### 17.01 *Giving Notice*

- A. Whenever any provision of the Contract Documents requires the giving of written notice, it will be deemed to have been validly given if:
  1. delivered in person to the individual or to a member of the firm or to an officer of the corporation for whom it is intended; or
  2. delivered at or sent by registered or certified mail, postage prepaid, to the last business address known to the giver of the notice.

### 17.02 *Computation of Times*

- A. When any period of time is referred to in the Contract Documents by days, it will be computed to exclude the first and include the last day of such period. If the last day of any such period falls on a Saturday or Sunday or on a day made a legal holiday by the law of the applicable jurisdiction, such day will be omitted from the computation.

### 17.03 *Cumulative Remedies*

- A. The duties and obligations imposed by these General Conditions and the rights and remedies available hereunder to the parties hereto are in addition to, and are not to be construed in any way as a limitation of, any rights and remedies available to any or all of them which are otherwise imposed or available by Laws or Regulations, by special warranty or guarantee, or by other provisions of the Contract Documents. The provisions of this Paragraph will be as effective as if repeated specifically in the Contract Documents in connection with each particular duty, obligation, right, and remedy to which they apply.

### 17.04 *Survival of Obligations*

- A. All representations, indemnifications, warranties, and guarantees made in, required by, or given in accordance with the Contract Documents, as well as all continuing obligations indicated in the Contract Documents, will survive final payment, completion, and acceptance of the Work or termination or completion of the Contract or termination of the services of Contractor.

### 17.05 *Controlling Law*

- A. This Contract is to be governed by the law of the state in which the Project is located.

### 17.06 *Headings*

- A. Article and paragraph headings are inserted for convenience only and do not constitute parts of these General Conditions.

# SUPPLEMENTARY CONDITIONS

Prepared by

**ENGINEERS JOINT CONTRACT DOCUMENTS COMMITTEE**

and

Issued and Published Jointly by



AMERICAN COUNCIL OF ENGINEERING COMPANIES

ASSOCIATED GENERAL CONTRACTORS OF AMERICA

AMERICAN SOCIETY OF CIVIL ENGINEERS

PROFESSIONAL ENGINEERS IN PRIVATE PRACTICE  
*A Practice Division of the*  
NATIONAL SOCIETY OF PROFESSIONAL ENGINEERS

Endorsed by



CONSTRUCTION SPECIFICATIONS INSTITUTE

---

EJCDC C-800 Supplementary Conditions – Nebraska  
Copyright © 2007 National Society of Professional Engineers for EJCDC. All rights reserved.

---

Copyright © 2007 National Society of Professional Engineers  
1420 King Street, Alexandria, VA 22314-2794  
(703) 684-2882  
[www.nspe.org](http://www.nspe.org)

American Council of Engineering Companies  
1015 15th Street N.W., Washington, DC 20005  
(202) 347-7474  
[www.acec.org](http://www.acec.org)

American Society of Civil Engineers  
1801 Alexander Bell Drive, Reston, VA 20191-4400  
(800) 548-2723  
[www.asce.org](http://www.asce.org)

Associated General Contractors of America  
2300 Wilson Boulevard, Suite 400, Arlington, VA 22201-3308  
(703) 548-3118  
[www.agc.org](http://www.agc.org)

The copyright for this EJCDC document is owned jointly by the four  
EJCDC sponsoring organizations and held in trust for their benefit by NSPE.



## Supplementary Conditions

These Supplementary Conditions amend or supplement the Standard General Conditions of the Construction Contract (C-700, 2007 Edition) and other provisions of the Contract Documents as indicated below. All provisions that are not so amended or supplemented remain in full force and effect.

The terms used in these Supplementary Conditions will have the meanings indicated in the General Conditions. Additional terms used in these Supplementary Conditions have the meanings stated below, which are applicable to both the singular and plural thereof.

### TABLE OF CONTENTS

		<b>Page</b>
SC-1.01.A.3	Application for Payment Form	2
SC-1.01.A.9	Change Order Form	2
SC-2.02	Copies of Drawings to be Furnished	2
SC-2.03	Contract Times	2
SC-4.02	Reports of subsurface Conditions	2
SC-4.06	Hazardous Environmental Conditions	2
SC-5.04	Limits of Liability	2
SC-6.17	Submittals	4
SC-9.03	Project Representative	4

**SC-1.01.A.3. Add the following language to the end of Paragraph 1.01.A.4:**

The Application for Payment form to be used on this Project is EJCDC No. C-620.

**SC-1.01.A.9. Add the following language to the end of Paragraph 1.01.A.10:**

The Change Order form to be used on this Project is EJCDC No. C-941.

**SC-2.02. Delete Paragraph 2.02.A in its entirety and insert the following in its place:**

- A. Owner shall furnish to Contractor up to 4 printed or hard copies of the Drawings and Project Manual and one set in electronic format. Additional copies will be furnished upon request at the cost of reproduction.

**SC-2.03. Delete Paragraph 2.03.A in its entirety and insert the following in its place:**

- A. The Contract Times will commence to run on the day indicated in the Notice to Proceed. A Notice to Proceed may be given at any time within 30 days after the Effective Date of the Agreement.

**SC-4.02. Delete Paragraphs 4.02.A and 4.02.B in their entirety and insert the following:**

- A. No reports of explorations or tests of subsurface conditions at or contiguous to the Site, or drawings of physical conditions relating to existing surface or subsurface structures at the Site, are known to Owner.
- B. Not Used

**SC-4.06. Delete Paragraphs 4.06.A and 4.06.B in their entirety and insert the following:**

- A. No reports or drawings related to Hazardous Environmental Conditions at the Site are known to Owner.
- B. Not Used

**SC-5.04. Add the following new paragraph immediately after Paragraph 5.04.B:**

- C. The limits of liability for the insurance required by Paragraph 5.04 of the General Conditions shall provide coverage for not less than the following amounts or greater where required by Laws and Regulations:
  - 1. Workers' Compensation, and related coverages under Paragraphs 5.04.A.1 and A.2 of the General Conditions:
    - a. State: Statutory
    - b. Applicable Federal (e.g., Longshoreman's): Statutory

- c. Employer's Liability: \$500,000
- 2. Contractor's General Liability under Paragraphs 5.04.A.3 through A.6 of the General Conditions which shall include completed operations and product liability coverages and eliminate the exclusion with respect to property under the care, custody and control of Contractor:
  - a. General Aggregate \$1,000,000
  - b. Products - Completed Operations Aggregate \$1,000,000
  - c. Personal and Advertising Injury \$1,000,000
  - d. Each Occurrence (Bodily Injury and Property Damage) \$1,000,000
  - e. Property Damage liability insurance will provide Explosion, Collapse, and Under-ground coverages where applicable.
  - f. Excess or Umbrella Liability
    - 1) General Aggregate \$1,000,000
    - 2) Each Occurrence \$1,000,000
- 3. Automobile Liability under Paragraph 5.04.A.6 of the General Conditions:
  - a. Bodily Injury:
    - Each person \$1,000,000
    - Each Accident \$1,000,000
  - b. Property Damage:
    - Each Accident \$1,000,000
  - c. Combined Single Limit of \$1,000,000
- 4. The Contractual Liability coverage required by Paragraph 5.04.B.4 of the General Conditions shall provide coverage for not less than the following amounts:
  - a. Bodily Injury:
    - Each person \$1,000,000
    - Each Accident \$1,000,000

b. Property Damage:	
Each Accident	\$1,000,000
Annual Aggregate	\$1,000,000

**SC-6.17 Add the following new paragraphs immediately after Paragraph 6.17.E:**

1. Contractor shall furnish required submittals with sufficient information and accuracy in order to obtain required approval of an item with no more than three submittals. Engineer will record Engineer's time for reviewing subsequent submittals of Shop Drawings, samples, or other items requiring approval and Contractor shall reimburse Owner for Engineer's charges for such time.
2. In the event that Contractor requests a change of a previously approved item, Contractor shall reimburse Owner for Engineer's charges for its review time unless the need for such change is beyond the control of Contractor.

**SC-6.19 Add the following new paragraphs immediately after Paragraph 6.19.C:**

- D. The contractor agrees that its work will be done in a workmanlike manner equal to same or similar standard of work by other contractors in the same or similar locality.

**SC-9.03 Add the following new paragraphs immediately after Paragraph 9.03.A:**

- B. The Resident Project Representative (RPR) will be Engineer's employee or agent at the Site, will act as directed by and under the supervision of Engineer, and will confer with Engineer regarding RPR's actions. RPR's dealings in matters pertaining to the Work in general shall be with Engineer and Contractor. RPR's dealings with Subcontractors shall be through or with the full knowledge and approval of Contractor. The RPR shall:
  1. *Schedules:* Review the progress schedule, schedule of Shop Drawing and Sample submittals, and schedule of values prepared by Contractor and consult with Engineer concerning acceptability.
  2. *Conferences and Meetings:* Attend meetings with Contractor, such as preconstruction conferences, progress meetings, job conferences and other project-related meetings, and prepare and circulate copies of minutes thereof.
  3. *Liaison:*
    - a. Serve as Engineer's liaison with Contractor, working principally through Contractor's authorized representative, assist in providing information regarding the intent of the Contract Documents.
    - b. Assist Engineer in serving as Owner's liaison with Contractor when Contractor's operations affect Owner's on-Site operations.
    - c. Assist in obtaining from Owner additional details or information, when required for proper execution of the Work.

4. *Interpretation of Contract Documents:* Report to Engineer when clarifications and interpretations of the Contract Documents are needed and transmit to Contractor clarifications and interpretations as issued by Engineer.
5. *Shop Drawings and Samples:*
  - a. Record date of receipt of Samples and approved Shop Drawings.
  - b. Receive Samples which are furnished at the Site by Contractor, and notify Engineer of availability of Samples for examination.
6. *Modifications:* Consider and evaluate Contractor's suggestions for modifications in Drawings or Specifications and report such suggestions, together with RPR's recommendations, to Engineer. Transmit to Contractor in writing decisions as issued by Engineer.
7. *Review of Work and Rejection of Defective Work:*
  - a. Conduct on-Site observations of Contractor's work in progress to assist Engineer in determining if the Work is in general proceeding in accordance with the Contract Documents.
  - b. Report to Engineer whenever RPR believes that any part of Contractor's work in progress will not produce a completed Project that conforms generally to the Contract Documents or will imperil the integrity of the design concept of the completed Project as a functioning whole as indicated in the Contract Documents, or has been damaged, or does not meet the requirements of any inspection, test or approval required to be made; and advise Engineer of that part of work in progress that RPR believes should be corrected or rejected or should be uncovered for observation, or requires special testing, inspection or approval.
8. *Inspections, Tests, and System Startups:*
  - a. Verify that tests, equipment, and systems start-ups and operating and maintenance training are conducted in the presence of appropriate Owner's personnel, and that Contractor maintains adequate records thereof.
  - b. Observe, record, and report to Engineer appropriate details relative to the test procedures and systems start-ups.
9. *Records:*
  - a. Record names, addresses, fax numbers, e-mail addresses, web site locations, and telephone numbers of all Contractors, Subcontractors, and major Suppliers of materials and equipment.
  - b. Maintain records for use in preparing Project documentation.
10. *Reports:*

- a. Furnish to Engineer periodic reports as required of progress of the Work and of Contractor's compliance with the progress schedule and schedule of Shop Drawing and Sample submittals.
- b. Draft and recommend to the Engineer proposed Change Orders, Work Change Directives, and Field Orders. Obtain backup material from Contractor.
- c. Immediately notify Engineer of the occurrence of any Site accidents, emergencies, acts of God endangering the Work, damage to property by fire or other causes, or the discovery of any Hazardous Environmental Condition.

11. *Payment Requests:* Review Applications for Payment with Contractor for compliance with the established procedure for their submission and forward with recommendations to Engineer, noting particularly the relationship of the payment requested to the schedule of values, Work completed, and materials and equipment delivered at the Site but not incorporated in the Work.

12. *Certificates, Operation and Maintenance Manuals:* During the course of the Work, verify that materials and equipment certificates, operation and maintenance manuals and other data required by the Specifications to be assembled and furnished by Contractor are applicable to the items actually installed and in accordance with the Contract Documents, and have these documents delivered to Engineer for review and forwarding to Owner prior to payment for that part of the Work.

13. *Completion:*

- a. Participate in a Substantial Completion inspection, assist in the determination of Substantial Completion and the preparation of lists of items to be completed or corrected.
- b. Participate in a final inspection in the company of Engineer, Owner, and Contractor and prepare a final list of items to be completed and deficiencies to be remedied.
- c. Observe whether all items on the final list have been completed or corrected and make recommendations to Engineer concerning acceptance and issuance of the Notice of Acceptability of the Work.

C. The RPR shall not:

- 1. Authorize any deviation from the Contract Documents or substitution of materials or equipment (including "or-equal" items).
- 2. Exceed limitations of Engineer's authority as set forth in the Contract Documents.
- 3. Undertake any of the responsibilities of Contractor, Subcontractors, Suppliers, or Contractor's superintendent.

4. Advise on, issue directions relative to, or assume control over any aspect of the means, methods, techniques, sequences or procedures of Contractor's work unless such advice or directions are specifically required by the Contract Documents.
5. Advise on, issue directions regarding, or assume control over safety practices, precautions, and programs in connection with the activities or operations of Owner or Contractor.
6. Participate in specialized field or laboratory tests or inspections conducted off-site by others except as specifically authorized by Engineer.
7. Accept Shop Drawing or Sample submittals from anyone other than Contractor.
8. Authorize Owner to occupy the Project in whole or in part.

**SC-16.01. Delete Paragraphs 16.01.A, 16.01.B, and 16.01.C in their entirety and insert the following:**

- A. In the event the engineer cannot resolve the dispute the Owner or Contractor may request to submit it to nonbinding mediation with the location and mediator to be selected by agreement of the parties, and if not successful then the parties shall have all remedies available to them in law or in equity.

# Change Order

No. \_\_\_\_\_

Date of Issuance: \_\_\_\_\_ Effective Date: \_\_\_\_\_

Project: Water District 105- Scottsbluff, NE	Owner:	Owner's Contract No.:
Contract:		Date of Contract:
Contractor:		Engineer's Project No.: RM140169-00

**The Contract Documents are modified as follows upon execution of this Change Order:**

Description:

**Attachments (list documents supporting change):**

**CHANGE IN CONTRACT PRICE:**

**CHANGE IN CONTRACT TIMES:**

Original Contract Price:

\$ \_\_\_\_\_

[Increase] [Decrease] from previously approved Change Orders No. \_\_\_\_\_ to No. \_\_\_\_\_

\$ \_\_\_\_\_

Contract Price prior to this Change Order:

\$ \_\_\_\_\_

[Increase] [Decrease] of this Change Order:

\$ \_\_\_\_\_

Contract Price incorporating this Change

\$ \_\_\_\_\_

Original Contract Times:  Working days  Calendar days

Substantial completion (days or date): \_\_\_\_\_

Ready for final payment (days or date): \_\_\_\_\_

[Increase] [Decrease] from previously approved Change Orders No. \_\_\_\_\_ to No. \_\_\_\_\_:

Substantial completion (days): \_\_\_\_\_

Ready for final payment (days): \_\_\_\_\_

Contract Times prior to this Change Order:

Substantial completion (days or date): \_\_\_\_\_

Ready for final payment (days or date): \_\_\_\_\_

[Increase] [Decrease] of this Change Order:

Substantial completion (days or date): \_\_\_\_\_

Ready for final payment (days or date): \_\_\_\_\_

Contract Times with all approved Change Orders:

Substantial completion (days or date): \_\_\_\_\_

Ready for final payment (days or date): \_\_\_\_\_

RECOMMENDED:

By: \_\_\_\_\_  
Engineer (Authorized Signature)

Date: \_\_\_\_\_

Approved by Funding Agency (if applicable):  
\_\_\_\_\_

ACCEPTED:

By: \_\_\_\_\_  
Owner (Authorized Signature)

Date: \_\_\_\_\_

ACCEPTED:

By: \_\_\_\_\_  
Contractor (Authorized Signature)

Date: \_\_\_\_\_

Date: \_\_\_\_\_

EJCDC C-941 Change Order

Prepared by the Engineers Joint Contract Documents Committee and endorsed by the Construction Specifications Institute.

Page 1 of 2



# Change Order

## Instructions

### A. GENERAL INFORMATION

This document was developed to provide a uniform format for handling contract changes that affect Contract Price or Contract Times. Changes that have been initiated by a Work Change Directive must be incorporated into a subsequent Change Order if they affect Price or Times.

Changes that affect Contract Price or Contract Times should be promptly covered by a Change Order. The practice of accumulating Change Orders to reduce the administrative burden may lead to unnecessary disputes.

If Milestones have been listed in the Agreement, any effect of a Change Order thereon should be addressed.

For supplemental instructions and minor changes not involving a change in the Contract Price or Contract Times, a Field Order should be used.

### B. COMPLETING THE CHANGE ORDER FORM

Engineer normally initiates the form, including a description of the changes involved and attachments based upon documents and proposals submitted by Contractor, or requests from Owner, or both.

Once Engineer has completed and signed the form, all copies should be sent to Owner or Contractor for approval, depending on whether the Change Order is a true order to the Contractor or the formalization of a negotiated agreement for a previously performed change. After approval by one contracting party, all copies should be sent to the other party for approval. Engineer should make distribution of executed copies after approval by both parties.

If a change only applies to price or to times, cross out the part of the tabulation that does not apply.

## PAY ITEMS

### GENERAL

The entire construction of the Project shall be computed by multiplying the actual quantities of the Pay Items measured during the progress of the work and its completion by the unit price pertaining thereto as bid by the Contractor to whom the award is made and as accepted by the Owner. No payment will be made in addition to the amount allowed under the Pay Items for incidental work required to complete the work involved in the Project and to clean up the area in which the Contractor has worked.

All labor, tools, supplies and any and all other things required to do the construction work, involving, but not limited to the adjusting of water valves and curb stops, protection of water and gas mains, telephone and electric cables, storm, water and sanitary sewer, and moving on to and away from the job, and to complete the same in the manner acceptable to the Owner and the Engineer shall be included in said Pay Items which are defined as follows:

1. Mobilization

This pay item shall include all work incidental to the start-up and completion of this project.

This work shall consist of preparatory work and operations, including, but not limited to, those necessary for the movement of personnel, equipment, supplies, and incidentals to the project site; and for all other work and operations which must be performed or costs incurred before beginning work at the project site.

The Contractor must include all costs that he/she expects to incur for all movements of his/her equipment and personnel. Additional payments will not be made should the Contractor elect to move his/her equipment and/or crew to another project site before the contracted work is complete or if the Contractor fails to adequately assess the actual cost of Mobilization for the contracted work.

Payment for this item shall be based on the lump sum price bid and shall be for one mobilization for the entire project. Payment for this item will be made by the following schedule:

- (1) First payment to equal contractor's documented costs of obtaining contract bonds and insurance premiums up to a total amount of 25% of the total lump sum bid for mobilization (\$200.00 minimum).
- (2) A total of 50% of the lump sum bid for mobilization will be paid when the project is at least 5% complete based on total value of work completed.
- (3) The total lump sum bid for the mobilization will be paid when the project is at least 10% complete based on total value of work completed.

2. 8" PVC Water Line

This Pay Item shall include all labor, equipment, material, excavation, and backfill necessary to furnish and install new water main to the lines, grade, and size shown on the plans. Measurement for this item shall be end to end of the new work with no deductions made for valves and fittings. This item shall include furnishing and installing the detector system on the water main.

The Contractor shall be required to furnish and place additional fill material required to backfill the trenches to the original grade.

This item shall also include the removal of existing pipe and fittings and incidental removal of fences.

Payment for this Pay Item shall be made at the unit price bid per foot of new water main furnished, installed and ready for use.

3. 6" PVC Water Line

This Pay Item shall include all labor, equipment, material, excavation, and backfill necessary to furnish and install new water main to the lines, grade, and size shown on the plans. Measurement for this item shall be end to end of the new work with no deductions made for valves and fittings. This item shall include furnishing and installing the detector system on the water main.

The Contractor shall be required to furnish and place additional fill material required to backfill the trenches to the original grade.

This item shall also include the removal of existing pipe and fittings and incidental removal of fences.

Payment for this Pay Item shall be made at the unit price bid per foot of new water main furnished, installed and ready for use.

4. 8" Water Valve and Valve Box

This Pay Item shall include all labor, equipment, material, excavation, and backfill necessary to furnish and install each water valve and box as shown on the plans.

Payment for this Pay Item shall be made at the unit price bid per water valve and box furnished, installed and ready for use.

5. Fire Hydrant with Auxiliary Valve and Valve Box

This Pay Item shall include all labor, equipment, material, excavation, and backfill

necessary to furnish and install each fire hydrant complete with auxiliary six inch resilient wedge gate valve and valve box as shown on the plans and described in these specifications.

This Item shall also include the cost to furnish the fire hydrant at the depth of bury required or the cost to furnish and install extensions to adjust the fire hydrant to the required depth of bury.

Payment for this Pay Item shall be made at the unit price bid for each fire hydrant with auxiliary valve and box furnished, installed and ready for use.

6. Remove and Reset Existing Fire Hydrant with New Auxiliary Valve and Valve Box

This Pay Item shall include all labor, equipment, material, excavation, and backfill necessary to remove the existing fire hydrant and relocate it complete with a new auxiliary six inch resilient wedge gate valve and valve box as shown on the plans and described in these specifications.

This Pay Item may require additional fittings and/or water main, but the additional fittings and/or water main will be compensated under their respective Pay Items, not under this Pay Item.

Payment for this Pay Item shall be made at the unit price bid per fire hydrant relocated and ready for use.

7. 3" Water Service Connection

This Pay Item shall include all labor, equipment, material, excavation and backfill necessary to furnish and install the corporation stop, saddle, and all other fittings necessary to make the service connection. The cost of the service piping shall not be included in this item. This pay item shall also include the removal of the existing curb stop and curb box.

Payment for this Pay Item shall be made at the unit price bid per water service connection installed and ready for use.

8. 2" Water Service Connection

This Pay Item shall include all labor, equipment, material, excavation and backfill necessary to furnish and install the corporation stop, saddle, and all other fittings necessary to make the service connection. The cost of the service piping shall not be included in this item. This pay item shall also include the removal of the existing curb stop and curb box.

Payment for this Pay Item shall be made at the unit price bid per water service connection installed and ready for use.

9. 1" Water Service Connection

This Pay Item shall include all labor, equipment, material, excavation and backfill

necessary to furnish and install the corporation stop, saddle, and all other fittings necessary to make the service connection. The cost of the service piping shall not be included in this item. This pay item shall also include the removal of the existing curb stop and curb box.

Payment for this Pay Item shall be made at the unit price bid per water service connection installed and ready for use.

10. 3" Service Line

This Pay Item shall include all labor, equipment, material, excavation, backfill, and incidental items necessary to furnish and install water service piping and connecting to the service connection. This item shall include furnishing and installing the detector system on the water service piping.

This Pay Item shall also include the restoration of the existing landscape and replacement of pavement disturbed during installation of the service piping. The landscaping shall be restored to equal or better than original condition. This includes repairing any components of the existing sprinkler system that are damaged.

Removal and replacement of existing concrete or asphalt, the saw cutting as required, removal and disposal of said materials and placement of the dimension that was removed is included in the replacement.

Payment for this Pay Item shall be made at the unit price bid per foot of water service piping furnished, installed and ready for use.

11. 2" Service Line

This Pay Item shall include all labor, equipment, material, excavation, backfill, and incidental items necessary to furnish and install water service piping and connecting to the service connection. This item shall include furnishing and installing the detector system on the water service piping.

This Pay Item shall also include the restoration of the existing landscape and replacement of pavement disturbed during installation of the service piping. The landscaping shall be restored to equal or better than original condition. This includes repairing any components of the existing sprinkler system that are damaged.

Removal and replacement of existing concrete or asphalt, the saw cutting as required, removal and disposal of said materials and placement of the dimension that was removed is included in the replacement.

Payment for this Pay Item shall be made at the unit price bid per foot of water service piping furnished, installed and ready for use.

12. 1" Service Line

This Pay Item shall include all labor, equipment, material, excavation, backfill, and incidental items necessary to furnish and install water service piping and connecting to the service connection. This item shall include furnishing and installing the detector system on the water service piping.

This Pay Item shall also include the restoration of the existing landscape and replacement of pavement disturbed during installation of the service piping. The landscaping shall be restored to equal or better than original condition. This includes repairing any components of the existing sprinkler system that are damaged.

Removal and replacement of existing concrete or asphalt, the saw cutting as required, removal and disposal of said materials and placement of the dimension that was removed is included in the replacement.

Payment for this Pay Item shall be made at the unit price bid per foot of water service piping furnished, installed and ready for use.

13. Fittings

This Pay Item shall include all labor, equipment, material, excavation, and backfill necessary to furnish and install all sizes and types of water main fittings and accessories. This item shall include the fittings, joint restraints, gaskets, bolts, nuts, and concrete thrust blocks as shown on the plans or described in these specifications.

Payment for this Pay Item shall be made at the unit price bid per pound of fittings furnished, installed, and ready for use. Fitting weights will be based on published data for compact, **ductile iron**, mechanical joint body cast with joint accessories. The cost for the joint restraints and thrust blocks shall be considered subsidiary to this pay item.

14. Ball Locator

This item shall include all work, material, equipment, labor, placement and all other incidental work necessary to place a ball locator at all as indicated per the detail on the plans, described in the specifications, or directed in the field by the Engineer.

Payment for this item shall be made at the unit price bid per each ball locator placed and ready for use.

## SPECIAL PROVISIONS

### 1. General

This project is needed to improve water quality an additional feed to the water line that feeds Minatare. The maintenance of traffic in the project vicinity is very important to the businesses in the area as well as the City of Scottsbluff.

To satisfy the intent of the City and to have this project completed by the accepted completion date, work shall be so scheduled to minimize inconvenience and disruption of access to businesses at all times during construction.

### 2. Successful Bidder's Submittal

The successful bidder after the award of contract will be required to submit in addition to the administrative forms and certifications, a detailed work schedule, traffic control schedule, and business access plan. The submitted plan must be reviewed and approved by the City.

The successful contractor must submit a construction schedule outlining their proposed phasing plan and the anticipated dates each phase will begin and be completed at the pre-construction conference. The construction phasing plan and schedule shall be a detailed plan with respect to the vehicular traffic during construction, access to businesses, and traffic control during construction. The submitted plan must be reviewed and approved by the Engineer and the City of Scottsbluff.

### 3. Protection of Existing Utility Services

The Contractor shall protect all existing utility services and shall replace any damaged utility at his own expense. The Contractor will also be responsible for coordinating all utility relocation work with the appropriate utility company during the construction process.

## CONSTRUCTION SURVEYING

1. Owner and Contractor Responsibilities:

Each project will have the construction staking and surveying done by either the Contractor or the Owner. When the pay item "Construction Staking and Surveying" is shown on the bid form under Article 5, then the Contractor shall accomplish the requirements in Paragraph 3 of this Section. When the Owner has the responsibility to accomplish the construction staking and surveying shown in Paragraph 2 of this Section, then the pay item "Construction Staking and Surveying" will **not** be shown in the bid form.

2. Owner provided construction stakes, lines, and grades shall be provided by the Engineer and shall include:

- a. The Engineer will furnish and set construction stakes or benchmarks establishing lines and grades and will furnish the Contractor with all necessary information relating to them.
- b. The Contractor shall be responsible for the preservation of all stakes and marks. The cost of replacing any stakes or marks destroyed or disturbed by the Contractor shall be charged against, and deducted from, the payment for the work at the current rate of the engineer for each hour of the Engineer's survey time spent replacing the Contractor disturbed stakes and marks.
- c. The Owner will not be responsible for delays due to lack of stakes unless the Contractor, when moving onto the work, has given one week's notice that such stakes are needed. Thereafter, 48 hours notice is required.

3. Contractor provided construction stakes, lines, and grades:

- a. The plans and the bid proposal Schedule of Items will show the pay item "Construction Staking and Surveying" when the Contractor is responsible for survey staking requirements. Electronic files from the Engineer, if available, will be provided to the Contractor for a fee established by the Engineer for each individual project.
- b. Contractor Construction Staking shall consist of:
  - (1) Establishing or reestablishing the project centerline.
  - (2) Referencing or re-referencing all necessary control points.



(3) Running a circuit of bench levels to check or reestablish plan benchmarks.

(4) Setting other benchmarks as needed.

(5) Staking right-of-way or restaking right-of-way where needed if it has been previously staked and performing all construction layout and reference staking necessary for the proper control and satisfactory completion of all structures, grading, paving, drainage, and all other appurtenances required for the completion of the construction work and acceptance of the project.

c. Construction Requirements:

(1) (i) The construction staking shall be done by personnel who are trained and experienced in construction layout and staking of the type and kind required in the contract.

(ii) If the Contractor subcontracts the "Construction Staking and Surveying," the work shall be done under the direction of a registered Professional Engineer or registered Land Surveyor.

(2) All stakes, references, lines, grades, and batter boards which may be required for the construction operations shall be furnished, set, and properly referenced by the Contractor. The Contractor shall be solely and completely responsible for the accuracy of the line and grade of all features of the work. Any errors or apparent discrepancies found in previous surveys, plans, specifications, or special provisions shall be immediately called to the attention of the Engineer by the Contractor for correction or interpretation before proceeding with the work.

(3) Survey notes shall be clear, orderly, neat, and consistent with standard engineering practices. The Contractor shall provide the survey notes to the owner prior to acceptance of the project. The notes shall become the property of the Owner upon completion of the project. The survey notes shall be subject to inspection by the Owner or their representative at any time. If reproducible, hand written survey notes are not available, an electronic file of the survey information consistent with the construction plan reference points shall be provided in an acceptable format to the Owner.

- (4) The Contractor shall be responsible for the placement and preservation of adequate ties and references to all control points, whether established by him/her or found on the project, necessary for the accurate reestablishment of all base lines or centerlines shown in the plans. All land ties (i.e., section corners, fractional section corners, etc.) that may be lost or destroyed during construction shall be carefully referenced and replaced by a licensed Nebraska Land Surveyor. A copy of the completed survey and references to the corner or accessory shall be filed with the State Surveyor and with the County Surveyor for the county or counties in which the survey corner exists within 30 days of the date the activity is completed.
  - (5) The Contractor shall correct any deficient staking or construction work which resulted from inaccuracies in the staking operations or from the Contractor's failure to report inaccuracies in the plans or survey data furnished by the Engineer.
  - (6) Following a written request by the Contractor, the Engineer may approve the start of construction staking operations before the tentative or anticipated beginning date.
4. Construction staking and surveying will be measured as a lump sum for all surveying and staking requirements. Payment is full compensation for all work prescribed in Paragraph 3.

## **WATER MAIN DISTRIBUTION**

### **PART 1 GENERAL**

#### **1.01 SECTION INCLUDES**

- A. Public water distribution main and appurtenances.
- B. On-site domestic and fire suppression water service lines and appurtenances.

#### **1.02 RELATED SECTIONS**

- A. Excavation.
- B. Fill & Backfill.
- C. Portland Cement Concrete Paving.

#### **1.03 REFERENCES**

- B. AWWA Standard Specifications C605 Installation of PVC Pipe.
- C. AWWA Standard Specifications C600 Installation of DIP Pipe.
- D. Nebraska Health and Human Services – Regulations & Licensure – Recommended Standards for Water Works – Ten States Standards.

#### **1.04 SUBMITTALS**

- A. See General Conditions 1 - Administrative Requirements, for submittal procedures.
- B. Shop drawings to include material date and/or catalogue cuts for pipe, valves, manholes, rings/covers, fittings and service connection materials, etc.
- C. Record drawings – Accurate record of location and depth of utilities installed.

#### **1.05 QUALITY ASSURANCE**

- A. See General Conditions 1 - Quality Requirements for general requirements for testing and analysis.

#### **1.06 PROJECT CONDITIONS**

- A. Comply Nebraska Health and Human Services – Regulations & Licensure, and other State and local building and plumbing codes.
- B. Comply with other requirements specified.

### **PART 2 PRODUCTS**

#### **2.01 PIPE FOR WATER MAINS**

All water pressure pipe shall be poly vinyl chloride pipe PVC unless specifically indicated otherwise.

PVC & ductile iron pipe when allowed, shall be as specified on the plans and elsewhere in the specifications.

- A. DUCTILE IRON PIPE

---

WATER MAIN DISTRIBUTION SPECIFICATIONS  
2000-1

---

All ductile iron pipe shall conform to AWWA Specification C151 for ductile iron pipe and shall be Pressure Class 350. Ductile Iron pipe shall be equipped with mechanical joints conforming to appropriate AWWA standards and conforming to the provisions of ASA Specification A21.11 or, at the contractor's option, with "Fastite" or "Tyton" joints. Bolts for mechanical joints shall be cast or wrought iron and the contractor shall supply all jointing materials including bolts, nuts, washers, gaskets, etc. Pipe shall be tested as specified in the aforementioned Standard Specifications, and the manufacturer shall furnish certification that the requirements of such tests have been met.

The exterior surface of all pipe and fittings shall be coated with coal tar pitch varnish approximately 1 mil thick, applied at a temperature of approximately 400 degrees F. The inside surface of all pipe and fittings shall be coated with a cement mortar lining, conforming to the requirement of AWWA Specification C104.

All pipe and special castings shall be made of good quality and of such characteristics as shall make the metal of the casting strong, tough and of even grain and soft enough to satisfactorily admit drilling and cutting and shall be smooth, free from scales, blisters, and sandholes and defects of other nature which unfit them for the use for which they are intended. Plugging, drilling, burning or welding will not be allowed. The pipe shall be straight and true circles with inner and outer surfaces concentric.

No pipe shall be accepted, the weight of which shall be less than the standard weight by more than 5% and no special casting shall be accepted, the weight of which shall be less than the standard weight by more than 10%. The sum of the pipe weights, for each size, shall not exceed or be less than the standard weights by more than 2%.

The Engineer or his authorized agent shall be at liberty at all times to inspect, at the factory, the material, molding, coating and casting of the pipes and special conformity with these specifications.

#### B. POLYVINYL CHLORIDE PIPE (PVC)

Polyvinyl Chloride (PVC) pipe shall be Johns-Manville "Blue Brute", Certainteed "Vinyl Iron", or approved equal, and shall meet the requirements of AWWA Standard C900 for "Polyvinyl Chloride Pressure Pipe for Water", pressure Class 235. The pipe shall bear the seal of approval of the National Sanitation Foundation (NSF) for pipe transporting potable water and be Underwriters Laboratories (UL) listed. PVC pipe shall be furnished in ductile iron pipe equivalent outside diameters and furnished with single gasket, UniBell, push-on type joint or two-gasket coupling joint conforming to appropriate AWWA standards.

### 2.01 FITTINGS

Fittings shall be Class 250 fittings conforming to the latest AWWA Specifications C110, Gray-Iron and Ductile Iron Fittings for Water and Other Liquids, and C153, Ductile-Iron Compact Fittings for Water Service. Joints shall be mechanical or "Push-On" joints conforming to the latest AWWA Specifications C111. The outside surface of the fitting shall receive a bituminous coal tar base coating approximately 1 mil thick.

### 2.02 WATER SERVICE LINES

Residential service piping shall be of the size and type shown on the plans and as hereinafter specified.

---

WATER MAIN DISTRIBUTION SPECIFICATIONS  
2000-2

---

## POLETHYLENE (PE)

PE service line shall conform to ASTM Designation D3035, latest revision and AWWA C-901 latest revision. The PE service line shall be SDR-9 200 psi. Eagle Plastics Pure Care or approved equal.

All service line piping shall be snaked from side to side in the trench to allow for thermal expansion and contraction.

Fittings for water service lines shall be compression type and shall be compatible with the specified service line piping. Insert stiffeners shall be used for all non-metallic lines.

### **2.04 CORPORATION STOPS AND SERVICE CLAMPS**

Corporation stops shall be brass corporation stops with inlet end to suit tapping requirements and outlet for PVC or PB tubing. Corporation stops shall be Ford FB 1000, Mueller P-25008, or an approved corporation stop with AWWA tapered inlet thread (cc) and conductive compression connection (cts) outlet.

The corporation stops for DIP pipe may be installed by direct tapping or, at the contractor's option, by the use of service clamps. Service clamps will be required to install 2-inch corporation stops or larger. Corporation stops for PVC pipe shall be installed with the use of service clamps.

Service clamps, where required, shall be flat double strap, bronze metal, with Neoprene gaskets, and corporation stop AWWA tapered threads. Service clamps shall be manufactured by Ford 202BS series, Mueller BR2S Series or approved equal. Service clamps for PVC shall provide full support around the circumference of the pipe, and have a bearing area of sufficient width along the axis of the pipe so that the pipe will not be distorted when tightened.

### **2.05 VALVES**

- A. GATE VALVES - DELETED
- B. RESILIENT WEDGE GATE VALVES

Resilient wedge gate valves shall be manufactured to meet all applicable requirements of AWWA Specifications C509. Valves 12" and smaller shall be bubble-tight at 200 psi water working pressure. Valves shall have non-rising stems and shall be closed by turning right. Prior to shipment from the factory, each valve shall be tested by hydrostatic pressure equal to twice the specified pressure. All valves shall be American Darling AFC-2500 Resilient Wedge Ductile Iron Valve, or Clow Series 6100 Resilient Wedge Gate Valve, or Mueller Resilient Wedge Gate Valve A-2360. Where called for on the plans, the valves shall be equipped for a position indicator operator.

- C. BUTTERFLY VALVES

Where permitted butterfly valves shall conform with AWWA specifications C504 with bodies of cast iron, and shall have mechanical joint or flanged ends as specified elsewhere. Resilient seat disc shall be rigidly mounted to shaft and shall be capable of providing 360 degree seal. Valves shall be closed by turning right. Prior to shipment

from the factory, each valve shall be tested by hydrostatic pressure equal to twice the specified working pressure.

## **2.06 FIRE HYDRANTS**

The contractor shall furnish and install all fire hydrants at substantially the locations shown on the drawings. Hydrants shall be American Darling B-62-B long body. Hydrant shall be a non-freezing type and shall have a full flow valve. Each hydrant shall be fitted with two 2-1/2" standard nozzles and one 4-1/2" pumper nozzle. The nozzles shall have National Standard Thread unless otherwise specified. Nozzle caps are to be equipped with chains. Hydrants shall comply with the requirements of the AWWA Standard C502, latest revision, with a valve opening of at least 5-1/4" in diameter. Hydrants shall be ordered for a 5-1/2' bury unless otherwise approved by the Project Engineer.

Hydrant barrels shall be constructed in such a manner that it is not necessary to shut off the water or to excavate to make repairs. The barrel of the hydrant shall be constructed in sections which are to be jointed in such a manner that the upper section of the barrel extending above the ground may be separated from the lower section by impact without injury to the stem or the barrel.

The main valve construction at the bottom of the hydrant shall be such as to permit the water to drain from the hydrant barrel when the main valve is closed. The main valve stem seats and packing glands to be of bronze or approved rust resisting metal and to be constructed in such a manner as to be easily replaced without excavating. The main valve facing shall be made of rubber. Main valve shall open in a counter-clockwise direction.

The contractor shall furnish one hydrant wrench for each six hydrants or fraction thereof, and paint each hydrant with two coats of finish paint.

The ground elevation of the hydrant shall be within  $\pm 3$  inches of the bury line mark on the hydrant.

### **A. FINISH PAINT**

Priming and finish coats shall be as specified for the individual item. In general, it is the intention of these specifications to provide cleaning, prime coat, field touch-up of prime coat and all above ground metal parts shall be painted a finish coat with fire hydrant orange, or an approved equal.

## **2.07 STRUCTURES**

All structures (manholes, special manholes, headwalls, etc.) shall be constructed in accordance with the details shown on the plans and all materials used in their construction shall conform to the requirements set forth in these specifications. The construction of these items shall include placing the necessary sections of pipe for inlet and outlet lines through the walls of the structure.

Pre-cast concrete manholes, poured-in-place concrete manholes or parts of pre-cast concrete manholes of a design approved by the Engineer and of the dimensions required by the detailed plans may be used.

The height of concrete and pre-cast concrete manholes or parts of pre-cast concrete manholes construction shall be so adjusted with adjustment rings at the top of the manholes that the top of

the manhole ring and cover will be flush with the top of the finished replacement pavement or the grade established by the Engineer. Manholes shall be adjusted with 2 foot inside diameter concrete adjusting rings.

All cast-iron manhole rings shall be set to the correct line and grade and shall be mortared in place, on the top of the respective structures.

Manhole steps conforming to the detailed plans shall be set from the top to the bottom of each manhole.

All manholes of a depth of 6-1/2 feet or less shall be decked as shown on the drawings. All manholes in flood –prone areas will be flood proof.

## **2.08 VALVE BOXES**

All valve boxes shall be constructed in accordance with the details shown on the plans and all materials used in their manufacture and construction shall conform to the requirements set forth in these specifications. Valve boxes shall be screw type constructed of cast iron and be adjustable to the depth required at each location.

## **2.09 MANHOLE RING AND COVER**

Manhole covers shall not be ventilated unless specified on the drawings. The cover shall have at least one "Pick Slot" opening. The manhole ring and cover shall be of the same manufacture and design, with weight differential being in the rim to flange height. Manhole ring and covers shall be 350 pounds, with the exception of 450 pound traffic model being required for all covers subject to vehicle traffic.

## **2.10 CURB STOP AND BOX**

Curb stops shall be Ford B44-444, Mueller Oraseal Mark II, Model H15155 or approved equal, Minneapolis pattern with screw box mount, for PE tubing or an approved equal. The extension type curb box shall be Handley W21FK54ALR for Minneapolis pattern complete with cast iron plug style lid with standard pentagon bolt, or an approved equal. Curb stops installed for future connections shall have the open end of the curb stop capped with Mueller Brass Cap H-15540, or an approved equal.

## **2.11 DETECTOR SYSTEM FOR NON-METALLIC WATER MAIN AND SERVICE LINES**

A continuous metallic detector wire shall be installed along the entire length of PVC water main and non-metallic PE or PVC service lines. For service lines, the service's detector wire shall be attached to the main's detector wire. The wire shall be insulated 10 gauge wire suitable for direct bury. The wire shall be wrapped or fastened to all metallic fittings, valves and boxes, fire hydrants and curb stop boxes. A continuity test will be required for each reach between metallic connections before the next reach can be constructed. Splices shall be insulated and sealed with a direct bury wire connector splice. Wire connector splices shall be DBR low voltage splices manufactured by 3M or an approved equal.

## **2.12 BALL LOCATOR MARKERS**

Ball locator markers shall be installed per detail(s) on the project plans. All ball markers shall be 3M EMS Ball Marker 1403-XR as manufactured by 3M Infrastructure Protection Division or an approved equal.

## **PART 3 - RESPONSIBILITY AND HANDLING OF MATERIAL**

### **3.01 RESPONSIBILITY OF MATERIAL**

#### **A. RESPONSIBILITY OF MATERIAL FURNISHED BY CONTRACTOR**

The contractor shall be responsible for all material furnished by him and shall replace at his own expense all such material found defective in manufacture or damaged in handling after delivery by the manufacturer. This shall include the furnishing of all material and labor required for the replacement of installed material discovered defective prior to the final acceptance of the work.

#### **B. RESPONSIBILITY FOR MATERIAL FURNISHED BY OWNER**

The contractor's responsibility for material furnished by the Owner shall begin at the point of delivery thereof to said contractor. Materials already on the site shall become the contractor's responsibility on the day of the award of the contract. The contractor shall examine all materials furnished by the Owner at the time and place of delivery to him and shall reject all defective material.

Any material furnished by the Owner and installed by the contractor without discovery of such defects will, if found defective prior to final acceptance of the work, be replaced with sound material by the Owner. The contractor, however, shall at his own expense, furnish all supplies, labor and facilities necessary to remove said defective material and install the sound material in a manner satisfactory to the engineer.

#### **C. RESPONSIBILITY FOR SAFE STORAGE**

The contractor shall be responsible for the safe storage of material furnished by or to him, and accepted by him, and intended for the work, until it has been incorporated in the completed project. The interior of all pipe, fittings and other accessories shall be kept free from dirt and foreign matter at all times. Valves and hydrants shall be drained and stored in a manner that will protect them from damage by freezing.

#### **D. REPLACEMENT OF DAMAGED MATERIAL**

Any material furnished by the Owner that becomes damaged after acceptance by the contractor shall be replaced by the contractor at his own expense.

### **3.02 HANDLING OF MATERIAL**

#### **A. HAULING**

All material furnished by the contractor shall be delivered and distributed at the site by the contractor. Materials furnished by the Owner shall be picked up by the Contractor at points designed and hauled to and distributed at the site.

---

WATER MAIN DISTRIBUTION SPECIFICATIONS  
2000-6

---



Pipe, fittings, valves, hydrants and accessories shall be loaded and unloaded by lifting with hoists or skidding so as to avoid shock or damage. Under no circumstances shall such materials be dropped. Pipe handled on skidways shall not be skidded or rolled against pipe already on the ground.

**B. AT SITE OF WORK**

In distributing the material at the site of the work, each piece shall be unloaded opposite or near the place where it is to be loaded in the trench.

**C. CARE OF PIPE COATING AND LINING**

Pipe shall be so handled that the coating and lining will not be damaged. If, however, any part of the coating or lining is damaged, the repair shall be made by the contractor at his expense in a manner satisfactory to the Engineer.

**PART 4 – EXECUTION**

**4.01 ALIGNMENT AND GRADE**

**A. GENERAL**

The water main shall be laid and maintained to the required lines and grades with fittings, valves and hydrants at the required locations, spigots centered in bells, and all valves and hydrant stems plumb.

**B. DEVIATIONS OCCASIONED BY OTHER STRUCTURES**

Wherever obstructions not shown on the plans are encountered during the progress of the work and interfere to such an extent that an alteration in the plan is required, the Engineer shall have the authority to change the plans and order a deviation from the line and grade or arrange with the Owners of the structures for the removal, relocation, or reconstruction of the obstructions. If the change in plans results in a change in the amount of work by the Contractor, such altered work shall be done on the basis of payment to the contractor for extra work or credit to the Owner for less work.

**C. CAUTION IN EXCAVATION**

The contractor shall proceed with caution in the excavation and preparation of the trench so that the exact location of underground structures, both known and unknown, may be determined, and he shall be held responsible for the repair of such structures when broken or otherwise damaged because of carelessness on his part.

**D. SUBSUFACE EXPLORATIONS**

Whenever, in the opinion of the Engineer, it is necessary to explore and excavate to determine the location of existing underground structures, the contractor shall make explorations and perform additional work in making the explorations and excavations, and extra compensation will be allowed for such additional work.

**E. DEPTH OF PIPE**

---

WATER MAIN DISTRIBUTION SPECIFICATIONS  
2000-7

---

All pipe shall be laid for depth to maintain five (5) feet of cover below existing and proposed future street grades, except as shown or otherwise described on the plans.

#### 4.02 WATER LINES

##### A. GENERAL EXCAVATION AND PREPARATION OF TRENCH

The Contractor shall perform all excavation of every type and of whatever material encountered to the depths shown on the drawings as specified or as directed by the Engineer. Banks or trenches shall be kept as nearly vertical as practicable, or if required by the angle of repose of the material encountered, the banks may be sloped a reasonable amount when approved by the Engineer, or if required, the banks shall be properly sheeted and braced. The excavation of the trench shall not advance more than two hundred (200) feet ahead of the completed pipe work, except where in the opinion of the Engineer, it is necessary to drain wet ground. If excavation of pipe trench is made below grade due to the Contractor's fault, the proper grade shall be refilled with sand or fine gravel thoroughly compacted all at the contractor's expense. Material excavated from trenches shall be compactly placed adjacent to the excavation such that minimum inconvenience shall result to the public and adjacent property owners. All excavations shall be kept free of water.

##### B. OPEN CUTS

All excavation for pipe lines, conduits and structures shall be open cut from the ground surface and no tunneling will be required or permitted, except that in undercrossings of improved State Highways, railroads and other locations specifically shown on the plans, augered holes shall be made.

##### C. LINE AND GRADE

All excavation shall conform to the lines and grades shown on the Plans.

##### D. DEWATERING

The Contractor shall at his own expense keep all trenches for pipe lines and conduits and excavations for concrete structures free from water during excavation, fine grading pipe laying and jointing and while placing concrete and for 12 hours after concrete is placed. Sources of water considered in this requirement includes surface water, water from existing pipe drainage, precipitation as well as groundwater except where paid for directly.

If the bottoms of any excavation for concrete structures or pipeline should be mucky or otherwise unstable because of the pressure of groundwater, and in all cases when the groundwater elevation is above the bottom of any excavation, such groundwater shall be lowered by means of well points and pumps, or by other means acceptable to the Engineer, to the extent necessary to keep the excavation free from water and the bottom stable at all times when work within the excavated area is in progress. Surface water shall be diverted and prevented from entering excavations.

##### E. DIMENSIONS OF EXCAVATION

---

WATER MAIN DISTRIBUTION SPECIFICATIONS  
2000-8

---

1. Trenches

Trenches shall be excavated with sides as nearly vertical as possible, except as hereinafter provided. The width of the lower portion of all trenches from the subgrade up to a point 18" above the top of the pipe shall be such as to afford proper space for doing all necessary work around and beneath the pipe to be laid, for inspection after laying and for thoroughly consolidating the backfill under and around the pipe without injury to any coatings and for the satisfactory construction of all appurtenances, and for such bracing, sheeting, pumping and draining as may be necessary. The width of this lower portion of trenches, exclusive of any sheeting or bracing shall be a minimum of 12" and a maximum of 24" wider than the exterior diameter of the pipe to be laid therein. Above the 18" point, overhang will not be permitted but the trench sides may be sloped outward to decrease the over-burden loading or to afford better and safer working conditions.

2. Augered Holes

Where augered holes are required, the dimensions thereof shall be slightly smaller than the outside diameters of the pipes to be laid therein, so that no backfilling will be necessary, or at the contractor's option, the holes may be augered with the upper portion of sufficient size to permit adequate tamping and compacting of the backfill, provided that regardless of the methods used, all requirements of the Owners of the surface improvements involved shall be met, and that the finished pipe line shall be true to the line and grade provided on the plans.

3. Excavation for Structures

Excavation for structures shall be made with the sides as nearly vertical as possible. Except where buttresses or concrete conduits are to be built, excavation shall extend at least one foot beyond outside wall lines, provided footings may be placed in trenches formed in the ground and kept to the full dimensions of the footings until during the time that the concrete is poured.

Buttress excavation shall conform with the backside of the buttress and for conduits, with overall width of the conduit.

All concrete structures shall rest on original undisturbed earth. Any excavation below the specified structure subgrade shall be replaced by and at the expense of the contractor, with concrete monolithic with that of the structure above.

F. ROUGH AND FINISH EXCAVATION

Rough excavation shall not extend lower than an elevation 3" above the finished pipe or structure subgrade elevation at any point except where a special fill is required. The remaining portion of the excavation shall be made with hand tools as the subgrade is being prepared. Pipe trenches shall be of uniform width, and shall be aligned and excavated in such a manner that the pipe, when laid in specified and accurate alignment will be centered therein.

G. SUBGRADE MATERIAL

Subgrade material for all structures and pipe lines shall be firm, thoroughly consolidated and free from mud and muck. It shall be sufficiently stable to remain firm and intact under the feet of the workmen engaged in fine grading, laying pipe, placing reinforcement steel and depositing concrete thereon, and if for any reason these conditions cannot be secured, the Engineer may authorize such special construction as may be deemed necessary.

H. TRENCH BOTTOMS

The trench bottom shall be so formed that the pipe to be laid thereon will conform to the established alignment and grade and shall be accurately shaped to provide uniform bearing and support for the bottom and lower quadrant of each pipe at every point along its entire length between bell holes.

Except where special fill beneath the pipe is required, or concrete embedment is directed, the grade and elevation of all pipe shall be determined by the grade of the trench bottom, and no pipe shall be raised above the prepared subgrade to obtain the proper pipe elevation. In the event that, after placing a pipe in the trench, it is found that the prepared trench bottom is not at the proper elevation, the pipe shall be removed and the grade corrected. In no case shall the pipe be raised from and dropped on the trench bottom for the purpose of lowering a subgrade which is too high. If the trench is excavated too deep, it shall be brought to proper subgrade elevation, at the contractor's cost and expense by thoroughly compacting sand or fine gravel to the proper grade.

I. HOLES FOR PIPE JOINTS

At all pipe joints, additional excavation to the trench bottom and sides shall be made so as to permit the operations of jointing, caulking, coating, grouting, inspection, etc., in a manner satisfactory to the Engineer. Rough excavations in hard materials, which require the use of a special fill beneath the pipe, shall be made prior to the placing of the special backfill material.

J. SUBGRADE STABILIZATION

If at any point the subgrade material is unsuitable, in the opinion of the Engineer, to support the pipe or concrete structure in a satisfactory manner, the contractor shall excavate such unsatisfactory material to a depth determined by the Engineer and backfill with crushed rock, road gravel or other approved materials. Where necessary, such backfill material shall be tamped into the subgrade on which to lay the pipe. The cost of any such crushed rock or other backfill material which may be required, including the cost of removing unsatisfactory subgrade material below the normal subgrade, will be paid for as an item of extra work at unit prices submitted with the accepted proposal, or at a unit price to be agreed upon by Engineer and Contractor, with approval of the Owner, prior to the starting of such stabilization fill.

K. ROCK CLEARANCE

Any ledge rock, shale, stones or boulders shall be removed to provide a minimum clearance of 6 inches at the sides and bottom of the pipe to be laid, or the structure to be built in rock excavation. All material so removed shall be replaced, below and to the elevations of the finished grade with material suitable for bedding. This bedding material

shall be compacted by pneumatic tamping and the grade prepared as hereinbefore specified.

L. TRENCH SAFETY

The contractor shall be responsible to provide safe working conditions within the trench by sloping the trench sides sufficiently to decrease overburden loading and to prevent caving or sliding of the trench sides. If adequate space is not available, the contractor shall be responsible for properly and substantially bracing and sheeting all excavations as required to prevent caving or sliding and to provide adequate protection to workmen and to the pipe or structures being placed in such excavations. All trench safety regulations established by local, state or federal agencies shall be complied with at the contractor's cost.

**4.03 LAYING OF PIPE**

A. HANDING OF WATER MAIN MATERIAL INTO TRENCH

Proper implements, tools, facilities satisfactory to the Engineer shall be provided and used by the contractor for the safe and convenient prosecution of the work. All pipe, fittings, valves and hydrants shall be carefully lowered into the trench piece by piece by means of a derrick, ropes or other suitable tools or equipment, in such a manner as to prevent damage to water main materials and protective coatings and linings. Under no circumstances shall materials be dropped or dumped into the trench.

B. CLEANING PIPE AND FITTINGS

All dirt and other latencies shall be removed from the bell-and-spigot end of each pipe and the outside of the spigot and the inside of the bell shall be wire-brushed and wiped clean and dry and free from oil and grease before the pipe is laid.

C. LAYING PIPE

Every precaution shall be taken to prevent foreign material from entering the pipe while it is being placed in the line. If the pipe-laying crew cannot put the pipe into the trench and in place without getting earth into it, the Engineer may require that before lowering the pipe into the trench, a heavy, tightly woven canvas bag of suitable size shall be placed over each end and left there until the connection is to be made to the adjacent pipe. During laying operations, no debris, tools, clothing or other materials shall be placed in the pipe.

After placing a length of pipe in the trench, the spigot end shall be centered in the bell and the pipe forced home and brought to correct line and grade. The pipe shall be secured in place with approved backfill material tamped under except at the bells. Pipe and fittings which do not allow a sufficient and uniform space for joints shall be removed and replaced with pipe and fittings of proper dimensions to insure such uniform space. Precautions shall be taken to prevent dirt from entering the joint space.

At times when pipe laying is not in progress, the open ends of pipe shall be closed by a watertight plug or other means approved by the Engineer. This provision shall apply during the noon hour as well as overnight. If water is in the trench, the seal shall remain in place until the trench is pumped completely dry.

All pipe shall be covered with two to three feet of soil at the end of each work day to protect against damage to the pipe from trench collapse or flooding.

D. CUTTING PIPE

The cutting of pipe for inserting valves, fitting or closure pieces shall be done in a neat and workmanlike manner without damage to the pipe or its lining, so as to leave a smooth end at right angles to the axis of the pipe.

When machine cutting is not available for cutting pipe 20 inches in diameter or larger, the electric-arc cutting method will be permitted, using a carbon or steel rod. Only qualified and experienced workmen shall be used in this work.

E. BELL ENDS TO FACE DIRECTION OF LAYING

Pipe shall be laid with bell ends facing in the direction of laying, unless directed otherwise by the Engineer.

F. PERMISSIBLE DEFLECTION AT JOINTS

Wherever it is necessary to deflect pipe from a straight line, either in the vertical or horizontal plane, to avoid obstructions or plumb stems, or where long-radius curves are permitted, the amount of deflection allowed shall not exceed that specified by the AWWA or the manufacturer, and shall be approved by the Engineer.

G. RAILROAD AND STREET RAILWAY CROSSINGS

Work involved in highway or railroad crossings shall be conducted in strict accordance with the Specifications and requirements of the controlling agency. In the event that there are no specifications established by the controlling agency, auger holes are required to be of dimensions slightly smaller than the outside diameter of the pipe to be laid therein so that no backfilling will be necessary, or at the contractor's option, the holes may be augered with the upper portions of sufficient size to permit adequate tamping and compacting of the backfill provided that regardless of the method used, all requirements of the Owner of the surface improvements involved shall be met and that the finished pipeline shall be true to line and grade provided on the plans.

H. UNSUITABLE CONDITIONS FOR LAYING PIPE

No pipe shall be laid in water or when, in the opinion of the Engineer, trench conditions are unsuitable.

I. WATER AND SEWER LINE SEPARATION

Whenever a sewer and water line run parallel to one another, they shall be a minimum of ten (10) feet apart.

Whenever the water line crosses either above or under a sanitary or storm sewer line, the minimum vertical separation between the pipes shall be 18" measured from the outside diameter of the pipes. At the crossing, the water main shall be laid such that one full pipe (20' joint) shall be centered over or under the sewer main so the pipe joints are

equidistant and as far as possible from the sewer main. Special structural support for the upper pipe of the crossing shall be provided.

When a future sewer main is shown on the plan that will cross the water main, the water main shall be so installed to accommodate the above requirement for crossing.

J. CONTINUITY OF SERVICE

The citizens of the municipality must be served with utilities with all continuity possible. To that end, the contractor shall not discontinue service from any existing main until he is fully prepared with materials on the ground to perform the work necessary to fully restore service without excessive interruption. As nearly as possible, new mains and replacement of existing mains shall be built complete before service is interrupted for purposes of connection.

The contractor shall give adequate notice to citizens residing in the area of his intent to interrupt utility service. Service shall not be discontinued to any property overnight.

The contractor shall at all times maintain vehicular access to hospitals, fire stations and other sites where emergency service may be required in the public interest. Such access may be provided by temporary bridging of trenches, or such means as may be required.

The contractor shall not interrupt utility service for all citizens residing in the area for more than a maximum of four hours.

**4.04 JOINTING OF PUSH-ON JOINT PIPE**

A. GENERAL

The general requirements in this and all previous sections inclusive, shall apply except where the terms "bell" and/or "spigot" are used. They shall be considered to refer to the bell and spigot of the lengths of push on joint pipe.

B. VARIATIONS IN DIMENSIONS

The outside diameter of the spigot end of bell and spigot pipe varies with the type, size, and class of pipe. There is only one joint size for each diameter of push-on joint pipe. Thus, difficulty may be met when attempts are made to connect existing bell and spigot lines to push-on joint pipe.

C. CLEANING AND ASSEMBLING JOINT

The inside of the bell and the outside of the spigot end shall be thoroughly cleaned to remove oil, grit, excess coating, and other foreign matter. The circular rubber gasket shall be flexed inward and inserted in the gasket recess of the bell socket.

The gasket, inside surface of the bell and the outside surface of the spigot shall be lubricated with a thin film of gasket lubricant as supplied by pipe manufacturer and approved by the engineer.

The spigot end of the pipe shall be entered into the bell with care used to keep the joint from contacting the ground. The pipe shall be lined up with the previously installed pipe

and shall be pushed home using standard procedures approved by the engineer. The spigot end of the pipe shall be marked before assembly to assure that the spigot end is inserted to the full depth of the joint. Field cut pipe lengths shall be filed or ground to resemble the spigot end of such pipe as manufactured.

D. PERMISSIBLE DEFELECTION IN PUSH-ON JOINT PIPE

Whenever it is desirable to deflect push-on joint pipe, in order to form a long-radius curve, the amount of deflection shall not exceed the maximum limits recommended by AWWA in Standard No. C600.

**4.05 JOINING MECHANICAL-JOINT PIPE**

A. GENERAL

The general requirements in this and all previous sections inclusive, shall apply except that, where the terms "bell" and/or "spigot" are used, they shall be considered to refer to the bell and spigot ends of the lengths of mechanical-joint pipe.

B. VARIATIONS IN DIMENSIONS

The outside diameter of the spigot end of bell-and-spigot pipe varies with the type, size and class of pipe. There is only one joint size for each diameter of mechanical-joint pipe. Thus, difficulty may be met when attempts are made to connect existing bell-and-spigot lines to mechanical-joint pipe. When such a connection must be made, an adapter having a fitting bell and a mechanical-joint socket is manufactured and may be used. If the existing line ends in a spigot, either a standard sleeve or a special fitting consisting of a bell and mechanical-joint socket may be used, provided that the fitting between the spigot end of the existing line and the bell to be connected to it is consistent with the normal fit of bell-and-spigot pipe.

C. CLEANING AND ASSEMBLING JOINT

The last 8 inches outside of the spigot and inside of the bell of mechanical joint pipe shall be thoroughly cleaned to remove oil, grit, tar (other than standard coating), and other foreign matter from the joint, and then painted with a soap solution made by dissolving one-half (1/2) cup of granulated soap in one (1) gallon of water. The cast-iron gland shall then be slipped on the spigot end of the pipe with the lip extension of the gland toward the socket or bell end. The rubber gasket shall be painted with the soap solution and placed on the spigot end with the thick edge toward the gland.

D. BOLTING OF JOINT

The entire section of the pipe shall be pushed forward to seal the spigot end in the bell. The gasket shall then be pressed into place within the bells, being careful to have the gasket evenly located around the entire joint. The cast-iron gland shall be moved along the pipe into position for bolting, all of the bolts inserted, and the nuts screwed up tightly with the fingers. All nuts shall be tightened with a suitable (preferably torque-limiting) wrench. The torque for various sizes of bolts shall be as follows:

<u>Size (Inches)</u>	<u>Range of Torque (ft.-lb.)</u>
5/8	40-60



3/4	75-90
1	100-120
1-1/4	120-150

E. PERMISSIBLE DEFLECTION IN MECHANICAL-JOINT PIPE

Wherever it is desirable to deflect mechanical-joint pipe in order to form a long-radius curve, the amount of deflection shall not exceed the maximum limits recommended by AWWA in Standard No. C600.

**4.06 SETTING OF VALVES AND FITTINGS**

A. GENERAL

Valves, fittings, plugs and caps shall be set and jointed to pipe in the manner heretofore specified for cleaning, laying and jointing pipe.

B. LOCATION OF VALVES

Valves in water mains shall, where possible, be located on the street property lines extended unless otherwise shown on the plans.

C. VALVE BOXES AND VALVE PITS

A valve box or valve manhole shall be provided for every valve as specified on the plans. In the event that the plans do not specify the type of installation, a valve box shall be provided for every valve which has no gearing or operating mechanism or in which the gearing or operating mechanism is fully protected with a cast-iron grease case. The valve box shall not transmit shock or stress to the valve and shall be centered and plumb over the wrench nut of the valve, with the box cover flush with the surface of the finished pavement or such other level as may be directed.

A valve manhole shall be provided for every valve which has exposed gearing or operating mechanism. The valve nut shall be readily accessible for operation through the opening of the manhole which shall be set flush with the surface of the finished pavement or other such level as may be specified. Manholes shall be constructed as to permit minor valve repairs and afford protection to the valve and pipe from impact where they pass through the manhole walls.

**4.07 SETTING HYDRANTS**

A. LOCATION

Hydrants shall be located as shown or as directed and in a manner to provide complete accessibility, and also in such a manner that the possibility of damage from vehicles or injury to pedestrians will be minimized.

When placed behind the curb, the hydrant barrel shall be so set that no portion of the pumper or hose nozzle cap will be less than 24 inches from the gutter face of the curb.

When set in the lawn space between the curb and the sidewalk or between the sidewalk and the property line, no portion of the hydrant or nozzle cap shall be within 6 inches of the sidewalk.

**B. POSITION**

All hydrants shall stand plumb and shall have their nozzles parallel with or at right angles to the curb, with the pumper nozzle facing the curb, except that hydrants having two hose nozzles 90 degrees apart shall be set with each nozzle facing the curb at an angle of 45 degrees. Hydrants shall be set to a depth of 5-1/2 feet below established grade, with nozzles at least 12 inches above the ground, as shown or as directed by the Engineer.

**C. CONNECTION TO MAIN**

Each hydrant shall be connected to the main with a 6-inch branch of the same type of material as the water main controlled by an independent 6-inch resilient wedge valve, except as otherwise directed.

**D. HYDRANT DRAINAGE IN PERVIOUS SOIL**

Wherever a hydrant is set in soil that is pervious, drainage shall be provided at the base of the hydrant by placing coarse gravel or crushed stone mixed with coarse sand, from the bottom of the trench to at least 6 inches above the waste opening in the hydrant and to a distance of 1 ft. above the elbow. No drainage system shall be connected to a sewer.

**E. HYDRANT DRAINAGE IN IMPERVIOUS SOIL**

Wherever a hydrant is set in clay or other impervious soil, a drainage pit 2 feet in diameter and 3 feet deep shall be excavated below each hydrant and filled compactly with coarse gravel or crushed stone mixed with coarse sand, around and under the elbow of the hydrant and to a level of 6 inches above the waste opening. No drainage pit shall be connected to a sewer.

**4.08 ANCHORAGE**

**A. ANCHORAGE FOR HYDRANTS**

The bowl of each hydrant shall be well braced against unexcavated earth at the end of the trench with poured concrete thrust blocking or reaction backing and hydrant auxiliary valves, shall be tied to the main pipe or tee with all-thread tie rods or clamps, as shown or directed by the Engineer.

**B. ANCHORAGE FOR PLUGS, CAPS, TEES AND BENDS**

All plugs, caps, tees and bends, deflection 22-1/2 degrees or more on mains 4 inches in diameter or larger, shall be provided with thrust blocking and joint restraint as shown on the plans and described herein.

**C. THRUST BLOCKING**

Thrust blocks shall be cast-in-place concrete with a compressive strength of not less than 3,000 psi at 28 days. Thrust blocks shall be constructed between solid ground and the

fitting to be anchored; the area of bearing on the pipe and on the ground in each instance shall be that shown or directed by the Engineer. Precast blocking will not be allowed unless specifically approved by the Owner and Engineer. The thrust blocking shall, unless otherwise shown or directed, be so placed that the pipe and fitting joints will be accessible for repair.

D. JOINT RESTRAINT

Restraining glands of adequate strength to prevent movement shall be used with concrete thrust blocks as directed by the Engineer.

**4.09 BACKFILL**

A. DEFINITION OF SCOPE

The term "backfill" shall mean all necessary backfilling of trenches and other excavations, all backfill consolidation removal of surplus excavated material, all required surfacing, repair of pavements and gravel roads and all work incidental thereto.

B. BACKFILLING – WHEN TO BE DONE

1. For all pressure and non-pressure pipe, bedding and side cover shall follow the completion of pipe jointing as closely as is practicable and shall never be more than five lengths of pipe behind the laying operation.

At the Contractor's option, the balance of the backfill may be made prior to or after the tests for leakage as hereinafter specified have been completed, provided that the maximum unfilled length of trench at any time shall not exceed the spacing between any two adjacent manholes.

2. Around concrete structures as soon as the forms have been removed and the approval of the structure by the Engineer has been obtained.
3. Over sewers, the pipe bedding and side cover shall follow the completion of the pipe jointing as soon as such jointing is set or cured sufficiently to withstand the bedding operations, and the balance of the backfill shall follow immediately after the bedding has been placed.
4. Backfilling of trenches across roadways, driveways, pavements, etc., adjacent to drainage ditches and water course, shall not be done prior to the completion of backfilling of the trench on the upstream side, in order to prevent the impounding of water in the trench at any point after the pipe has been laid. All backfilling shall be done in such a manner that water will not accumulate in filled or partially filled trenches. All material deposited in roadway ditches or other water courses crossed by the line of trench shall be removed immediately after backfilling is completed and the cross section, grades and contours of such ditches or water courses restored as to their original condition.

C. BACKFILL MATERIAL

All backfill material shall be well pulverized, unfrozen and free from stones, hard lumps, clods, sticks and roots or other organic matter coarser than grass roots. No rock shall be

placed in the upper 12" or the lower 24" of any backfill; nor shall any rock, stone or boulder larger than 8" be included in any backfill. Stones less than 8" in size may be placed in the remainder of the backfill only if well separated and so arranged that no interference with backfill settlement will result. Broken pipe and concrete or other similar material shall not be used in any part of any backfill.

**D. BACKFILL COMPACTION**

1. All backfill, below, under and around the sides of all pipe up to an elevation 12" above the top of the pipe shall be deposited and hand tamped in layers not to exceed 6" in uncompacted thickness and shall be compacted to a density of 95% maximum Standard Proctor density, as determined by ASTM Designation D-698.
2. From one foot above the top of the pipe to the grade shown on the plans or specified herein, the trench shall be backfilled by hand or by an approved mechanical method.
3. All backfill over which pavement is to be placed, around structures, under dikes or roadway fills, backfill or trenches in the areas so designated on drawings, and within all street rights of way, shall be compacted to the top of the ground surface or to the subgrade of surfaces with suitable backfill material and be compacted to a minimum density of 95% maximum Standard Proctor density, as determined by ASTM Designation D-698.
4. All backfill of trenches not included in (1) and (2) above shall be made by means of scrapers or bulldozers and the excess material shall be windrowed over the ditch to a maximum depth of 12", a top width of 36" and with flat side slopes intersecting the natural ground surface. Just prior to the completion of other work of the project, this windrow shall be regraded so that all settlement is filled and the crown over the ditch is suitable for traffic.
5. Prior to any backfill, the excavated space around pipelines and structures shall be free from broken brick, stone and concrete, and of every kind of debris, so that only backfill materials, as defined above, shall be used in the backfill operation.
6. Except as provided in (1) above, compactions shall be accomplished by the expert use of pneumatic tamping tools and equipment. Care shall be taken that tamping tools do not come in contact with the pipe at any time, or within three inches of the surface of the top gradient hereof, or with the surfaces of structures.
7. Testing frequency for all trenches shall be at a minimum of two (2) per each street crossing and every 300 feet or fraction thereof unless otherwise specified on the plans or by the Engineer. The contractor shall be responsible for all costs associated with recompacting and retesting the backfill.

**PART 5 – TESTING**

All pressure and leakage test shall conform to the latest revision of AWWA C600.

**5.01 HYDROSTATIC PRESSURE TEST**

A hydrostatic pressure of not less than 150 pounds per square inch will be required and maintained for a period of two (2) hours.

A. PRESSURE TEST

After the pipe has been laid and partially backfilled, as specified in Section 4.08, all newly laid pipe or any valved section thereof shall be subjected to hydrostatic pressure stated in Section 5.01.

B. DURATION OF PRESSURE TEST

The duration of each pressure test shall be at least two hours.

C. PROCEDURE

Each valved section of pipe shall be slowly filled with water and the specified test pressure, based on the elevation of the lowest point of the line or section under test and corrected to the elevation of the test gauge, shall be applied by means of a pump connected to the pipe in a manner satisfactory to the Engineer. The pump, pipe connection and all necessary apparatus except gauges shall be furnished by the Contractor. The owner will furnish the gauges for the test and will make all taps into the pipe, but the Contractor shall furnish all necessary assistance for conducting the tests.

D. EXPELLING AIR BEFORE TEST

Before applying the specified test pressure, all air shall be expelled from the pipe. If hydrants or blowoffs are not available at high places, the Owner shall make the necessary taps at points of highest elevation before the test is made and insert the plugs after the test has been completed.

E. EXAMINATION UNDER PRESSURE

All exposed pipes, fittings, valves, hydrants and joints will be carefully examined during the open trench test. Any cracked or defective pipes, fittings, valves or hydrants discovered in consequence of this pressure test shall be removed and replaced by the contractor with sound material and the test shall be repeated until satisfactory to the Engineer.

**5.02 LEAKAGE TEST**

A leakage test shall be conducted after the pressure test has been satisfactorily completed. The Owner will furnish the gauge and measuring device for the leakage test. The contractor shall furnish the pump, pipe, connections and all other necessary apparatus, and shall furnish all necessary assistance to conduct the test. The duration of each leakage test shall be two hours, and during the test the main shall be subjected to a pressure of not less than 150 pounds per square inch.

Leakage shall be defined as the quantity of water that must be supplied into the newly laid pipe or any valved section thereof to maintain a pressure within 5 psi (35 MPa or 0.35 bar) of the specified test pressure after the pipe has been filled with water and the air has been expelled. Leakage shall not be measured by a drop in pressure in a test section over a period of time.

No pipe installation will be accepted if the leakage is greater than that determined by the following formula:

---

WATER MAIN DISTRIBUTION SPECIFICATIONS  
2000-19

---

$$L = \frac{SD\sqrt{P}}{148,000}$$

Where:

L = allowable leakage, in gallons per hour

S = length of pipe tested, in feet

D = nominal diameter of the pipe, in inches

P = average test pressure during the leakage test, in pounds per square inch (gauge)

These formulas are based on an allowable leakage of 10.49 gpd/mi/in. of nominal diameter at a pressure of 150 psi.

The allowable leakage at various pressures for pipe for various diameters is shown in AWWA Standard C605.

### **5.03 VARIATION FROM PERMISSIBLE LEAKAGE**

Should any test of pipe laid disclose leakage greater than that specified in AWWA Standard C605, the contractor shall at his own expense locate and repair the defective joints until the leakage is within the specified allowance.

### **5.04 PRESSURE AND LEAKAGE TEST AFTER BACKFILLING**

After the trench has been backfilled in accordance with Section 4.09, the test connections made and the main filled with water, the test sections shall be subjected to water pressure normal to the area. After examination of exposed parts of the system, the test pressure will be increased to the hydrostatic pressure specified and exposed parts again examined. If defects are found, the contractor shall immediately make the necessary repairs at his own expense. The Engineer will then repeat the pressure test until no defects are found. The duration of the final pressure test shall be at least two hours.

The leakage test shall be conducted after satisfactory completion of the pressure test, in accordance with Section 5.02. Should any test section fail to meet the leakage test, the contractor shall make the necessary repairs and retest the line at his own expense.

## **PART 6 - REMOVAL, RESTORATION AND MAINTENANCE OF SURFACE**

### **6.01 ALLOWABLE PAVEMENT REMOVAL**

The contractor shall remove pavement and road surfaces as a part of the trench excavation, and the amount removed shall depend upon the width of trench specified for the installation of the pipe and the width and length of the pavement area required to be removed for the installation of gate valves, special manholes or other structures. The width of pavement removed along the normal trench for the installation of the pipe shall not exceed the width of the trench specified by more than 6 inches on each side of the trench. The width and length of the area of pavement removed for the installation of gate valves, special manholes or other structures shall not exceed the maximum linear dimensions of such structures by more than 6 inches on each side. Wherever, in the opinion of the Engineer, existing conditions make it necessary to remove additional pavement, the contractor shall remove it as directed by the Engineer and shall receive

extra compensation therefore, provided such additional work is not shown in the drawings or specified. The contractor shall use such methods, either drilling or chipping, as will assure the breaking of the pavement along straight lines. The face of the remaining pavement shall be approximately vertical.

If the contractor removes or damages pavement or surfaces beyond the limits specified above, such pavement and surfaces shall be replaced or repaired at the expense of the contractor as specified.

#### **6.02 RESTORATION OF DAMAGED SURFACES AND PROPERTY**

Where any pavement, trees, shrubbery, fences, poles or other property and surface structures have been damaged, removed or disturbed by the contractor, whether deliberately or through failure to carry out the requirements of the contract documents, state laws, municipal ordinances or the specified direction of the Engineer, or through failure to employ usual and reasonable safeguards, such property and surface structures shall be replaced or repaired at the expense of the contractor.

#### **6.03 REPLACEMENT OF PAVEMENT AND STRUCTURES BY CONTRACTOR**

The contractor shall restore (unless otherwise stipulated) all pavement, sidewalks, curbing, gutters, shrubbery, fences, poles, sod or other property and surface structures removed or disturbed as part of the work to a condition equal to that before the work began, furnishing all labor and materials incidental thereto. In restoring the pavement, sound granite, blocks, sound brick, paving blocks may be reused. No permanent pavement shall be restored unless and until, in the opinion of the Engineer, the condition of the backfill is such as to properly support the pavement.

#### **6.04 CLEANING UP**

All surplus water main materials, furnished by the contractor and all tools and temporary structures shall be removed from the site by the contractor. All dirt, rubbish and excess earth from the excavation shall be hauled to a dump provided by the contractor and the construction site left clean to the satisfaction of the Engineer. All surplus water main materials furnished by the Owner and delivered to the site by the contractor shall be removed and delivered by the contractor to a location designated by the Owner. All surplus water main material furnished and delivered by the Owner shall be removed by the Owner.

### **PART 7 – DISINFECTING WATER MAINS**

#### **7.01 GENERAL**

Disinfection and bacteriological water sampling of new and repaired water main including pump discharge, transmission main and distribution piping on this project shall be done in accordance with AWWA specification C651 as provided herein.

#### **7.02 SCOPE**

This standard presents essential procedures for disinfecting new and repaired water mains. All new water mains shall be disinfected before they are placed in service. All water mains taken out of service for inspection, repair, or other activities that may lead to contamination of water shall be disinfected before they are returned to service.

### 7.03 REFERENCES

This standard references the following documents. The latest current edition of each forms a part of this standard where and to the extent specified herein. In case of any conflict, the requirements of this standard shall prevail.

ANSI/AWWA B300 - Standard for Hypochlorites.

ANSI/AWWA B301 - Standard for Liquid Chlorine.

*Simplified Procedures for Water Examination.* AWWA Manual M12. AWWA, Denver, (1978).

*Standard Methods for the Examination of Water and Wastewater.* APHA, AWWA, and WEF. \*\*\*  
Washington, D.C. (18th ed., 1992).

Additional materials relating to activity under this standard include the following:

*Chlorine Manual* - Chlorine Institute, Inc. \*\*\*\*

*Introduction to Water Treatment.* WSO Series, Vol. 2. AWWA, Denver (1984).

Material Safety Data Sheets for forms of chlorine used (provided by suppliers).

*Safety Practice for Water Utilities.* AWWA Manual M3. AWWA, Denver (1990).

*Water Chlorination Principles and Practices.* AWWA Manual M20. AWWA, Denver (1973).

*Water Quality and Treatment.* AWWA, Denver (4th ed., 1990).

---

\*American National Standards Institute Inc., 11 W. 42<sup>nd</sup> St., New York, NY 10036.

\*\*American Public Health Association, 1015 15<sup>th</sup> St., N.W., Washington, DC 20005.

\*\*\*Water Environment Federation, 601 Wythe St., Alexandria, VA 22314.

\*\*\*\*Chlorine Institute Inc., 2001 L St. N.W., Washington, DC 20036.

### 7.04 RECORD OF COMPLIANCE

The record of compliance shall be the bacteriological test results certifying the water sampled from the new water main to be free of coliform bacteria contamination, and to be equal to or better than the bacteriologic water quality in the distribution system.

### 7.05 FORMS OF CHLORINE FOR DISINFECTION

The forms of chlorine that may be used in the disinfection operations are liquid chlorine, sodium hypochlorite solution, and calcium hypochlorite granules or tablets.

#### A. LIQUID CHLORINE

Liquid chlorine conforming to ANSI/AWWA B301 contains 100 percent available chlorine and is packaged in steel containers usually of 100-lb., 150-lb., or 1-ton (45.4-kg, 68.0-kg, or 907.2-kg) net chlorine weight. Liquid chlorine shall be used only (1) in combination with appropriate gas-flow chlorinators and ejectors to provide a controlled high-concentration solution feed to the water to be chlorinated; (2) under the direct supervision of a person who is familiar with the physiological, chemical, and physical properties of liquid chlorine, and who is trained and equipped to handle any emergency that may arise; and (3) when appropriate safety practices are observed to protect working personnel and the public.



B. SODIUM HYPOCHLORITE

Sodium hypochlorite conforming to ANSI/AWWA B300 is available in liquid form in glass, rubber-lined, or plastic containers typically ranging in size from 1 qt (0.95 L) to 5 gal (18.92 L). Containers of 30 gal (113.6 L) or larger may be available in some areas. Sodium hypochlorite contains approximately 5 percent to 15 percent available chlorine, and care must be taken to control conditions and length of storage to minimize its deterioration. (Available chlorine is expressed as a percent of weight when the concentration is 5 percent or less, and usually as a percent of volume for higher concentrations. Percent x 10 = grams of available chlorine per liter of hypochlorite.)

C. CALCIUM HYPOCHLORITE

Calcium hypochlorite conforming to ANSI/AWWA B300 is available in granular form or in 5-g tablets, and contains approximately 65 percent available chlorine by weight. **Granular form will not be an allowable form for this project.** The material should be stored in a cool, dry, and dark environment to minimize its deterioration.

**7.06 BASIC DISINFECTION PROCEDURE**

The basic disinfection procedure consists of

- A. Preventing contaminating materials from entering the water main during storage, construction, or repair.
- B. Removing, by flushing or other means, those materials that may have entered the water main.
- C. Chlorinating any residual contamination that may remain, and flushing the chlorinated water from the main.
- D. Protecting the existing distribution system from backflow due to hydrostatic pressure test and disinfection procedures.
- E. Determining the bacteriological quality by laboratory test after disinfection.
- F. Final connection of the approved new water main to the active distribution system.

**7.07 PREVENTATIVE AND CORRECTIVE MEASURES DURING CONSTRUCTION**

Heavy particulates generally contain bacteria and prevent even very high chlorine concentrations from contacting and killing such organisms. It is, therefore, essential that the procedures of this section be observed to assure that water main and its appurtenances are thoroughly clean for the final disinfection by chlorination. Also, any connection of new water main to the active distribution system prior to receipt of satisfactory bacteriological samples may constitute a cross-connection. Therefore, the new main must be isolated until bacteriological tests described in Section 7.10 of this standard are satisfactorily completed.

- A. KEEPING PIPE CLEAN AND DRY

Precautions shall be taken to protect the interiors of pipes, fittings, and valves against contamination. Pipe delivered for construction shall be strung so as to minimize the entrance of foreign material. All openings in the pipeline shall be closed with watertight plugs when pipe laying is stopped at the close of the day's work or for other reasons, such as rest breaks or meal periods. Rodent-proof plugs may be used when it is determined that watertight plugs are not practicable and when thorough cleaning will be performed by flushing or other means.

Delay in placement of delivered pipe invites contamination. The more closely the rate of delivery is correlated to the rate of pipe laying, the lower the risk of contamination.

B. JOINTS

Joints of all pipe in the trench shall be completed before work is stopped. If water accumulates in the trench, the plugs shall remain in place until the trench is dry.

C. PACKING MATERIALS

Yarning or packing material shall consist of molded or tubular rubber rings, rope of treated paper, or other approved materials. Materials such as jute or hemp shall not be used. Packing material shall be handled in a manner that avoids contamination. If asbestos rope is used, it shall be handled in a manner that prevents asbestos from being introduced into the water-carrying portion of the pipe.

D. SEALING MATERIALS

No contaminated material or any material capable of supporting prolific growth of microorganisms shall be used for sealing joints. Sealing material or gaskets shall be handled in a manner that avoids contamination. The lubricant used in the installation of sealing gaskets shall be suitable for use in potable water. It shall be delivered to the job in closed containers and shall be kept clean.

E. CLEANING AND SWABBING

If dirt enters the pipe, it shall be removed and the interior pipe surface swabbed with a 1 percent hypochlorite disinfecting solution. If, in the opinion of the purchaser (or the purchaser's representative), the dirt remaining in the pipe will not be removed by the flushing operation, then the interior of the pipe shall be cleaned by mechanical means such as a hydraulically propelled foam pig (or other suitable device acceptable to the purchaser) in conjunction with the application of a 1 percent hypochlorite disinfecting solution to the interior pipe surface. The cleaning method used shall not force mud or debris into the interior pipe-joint spaces and shall be acceptable to the purchaser.

F. WET-TRENCH CONSTRUCTION

If it is not possible to keep the pipe and fittings dry during installation, every effort shall be made to ensure that any of the water that may enter the pipe-joint spaces contains an available-chlorine concentration of approximately 25 mg/L. This may be accomplished by adding calcium hypochlorite granules or tablets to each length of pipe before it is lowered into a wet trench, or by treating the trench water with hypochlorite tablets.

G. FLOODING BY STORM OR ACCIDENT DURING CONSTRUCTION

If the main is flooded during construction, it shall be cleared of the floodwater by draining and flushing with potable water until the main is clean. The section exposed to the floodwater shall then be filled with a chlorinated potable water that, at the end of a 24-h holding period, will have a free chlorine residual of not less than 25 mg/L. The chlorinated water may then be drained or flushed from the main. After construction is completed, the main shall be disinfected using the continuous-feed or slug method.

H. BACKFLOW PROTECTION (Optional)<sup>1</sup>

As an optional procedure (if specified by the purchaser), the new water main shall be kept isolated from the active distribution system by physical separation (see Figure 1) until satisfactory bacteriological testing has been completed and the disinfectant water flushed out. Water required to fill the new main for hydrostatic pressure testing, disinfection, and flushing shall be supplied through a temporary connection between the distribution system and the new main. The temporary connection shall include an appropriate cross-connection control device consistent with the degree of hazard, and shall be disconnected (physically separated) from the new main during the hydrostatic pressure test. It will be necessary to reestablish the temporary connection after completion of the hydrostatic pressure test to flush out the disinfectant water prior to final connection of the new main to the distribution system.

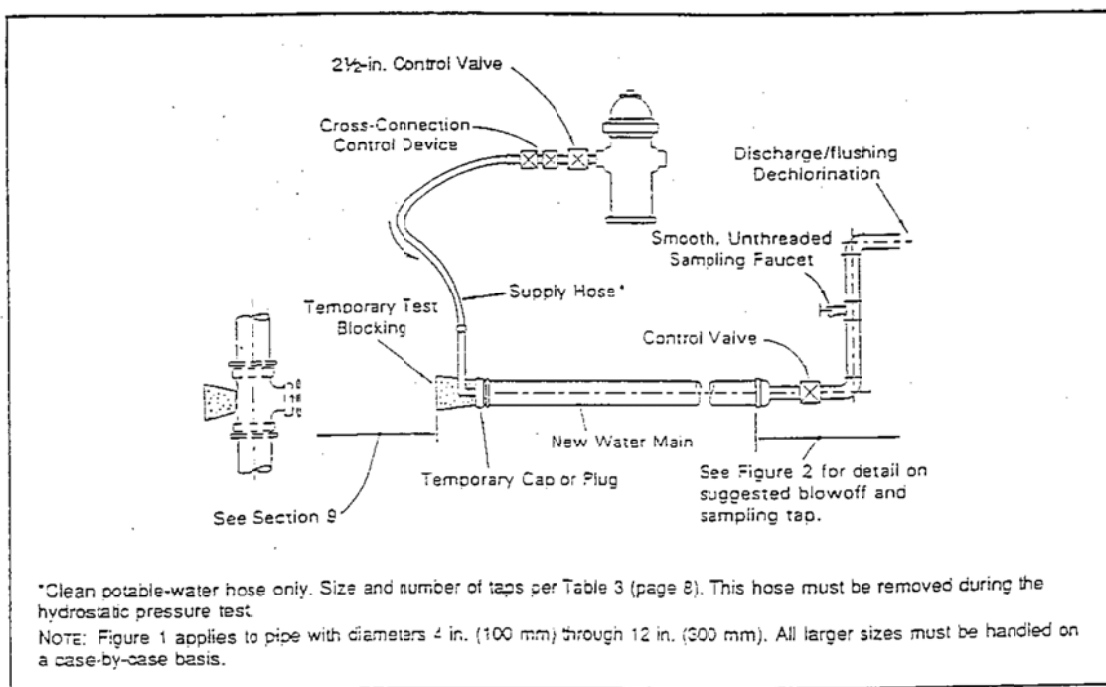

Figure 1 Suggested temporary flushing/testing connection

<sup>1</sup>Optional Section 7.07-H is not included as part of the standard unless specifically identified in the purchaser's specifications.

## 7.08 METHODS OF CHLORINATION

Three methods of chlorination are explained in this section: tablet, continuous feed, and slug. Information in the foreword will be helpful in determining the method to be used. The tablet method gives an average chlorine dose of approximately 25 mg/L; the continuous-feed method gives a 24-h chlorine residual of not less than 10 mg/L; and the slug method gives a 3-h exposure of not less than 50 mg/L free chlorine.

TABLE 1  
Ounces of calcium hypochlorite granules to be placed at beginning of main and at each  
500-ft interval

Pipe Diameter		Calcium Hypochlorite Granules	
<i>in.</i>	<i>(mm)</i>	<i>oz.</i>	<i>(g)</i>
4	(100)	0.5	(14)
6	(150)	1.0	(28)
8	(200)	2.0	(57)
12	(250)	4.0	(113)
16 and larger	(400 and larger)	8.0	(227)

7.08.1 Tablet Method

The tablet method consists of placing calcium hypochlorite granules or tablets in the water main as it is being installed and then filling the main with potable water when installation is completed.

This method may be used only if the pipes and appurtenances are kept clean and dry during construction.

- a. *Placing of calcium hypochlorite granules.* During construction, calcium hypochlorite granules shall be placed at the upstream end of the first section of pipe, at the upstream end of each branch main, and at 500-ft intervals. The quantity of granules shall be as shown in Table 1.

**WARNING:** *This procedure must not be used on solvent-welded plastic or on screwed-joint steel pipe because of the danger of fire or explosion from the reaction of the joint compound with the calcium hypochlorite.*

- b. *Placing of calcium hypochlorite tablets.* During construction, 5-g calcium hypochlorite tablets shall be placed in each section of pipe. Also, one such tablet shall be placed in each hydrant, hydrant branch, and other appurtenance. The number of 5-g tablets required for each pipe section shall be  $0.0012 d^2 L$  rounded to the next higher integer, where  $d$  is the inside pipe diameter, in inches, and  $L$  is the length of the pipe section, in feet. Table 2 shows the number of tablets required for commonly used sizes of pipe. The tablets shall be attached by a food-grade adhesive.<sup>1</sup> There shall be no adhesive on the tablet except on the broadside attached to the surface of the pipe. Attach all the tablets inside and at the top of the main, with approximately equal numbers of tablets at each end of a given pipe length. If the tablets are attached before the pipe section is placed in the trench, their position shall be marked on the section so it can be readily determined that the pipe is installed with the tablets at the top.

- c. *Filling and contact.* When installation has been completed, the main shall be filled with water at a rate such that water within the main will flow at a velocity no greater than 1 ft/s (0.3 m/s). Precautions shall be taken to ensure that air pockets are eliminated. This water shall remain in the pipe for at least 24 h. If the water temperature is less than 41°F (5°C), the water shall remain in the pipe for at least 48 h. As an optional procedure (if specified by the purchaser), water used to fill the new main shall be supplied through a temporary connection that shall include an appropriate cross-connection control device, consistent with the degree of hazard, for backflow protection of the active distribution system (see Figure 1).

TABLE 2  
Number of 5-g calcium hypochlorite tablets required  
for dose of 25 mg/L\*

Pipe Diameter		Length of Pipe Section, ft (m)				
		13 (4.0) or less	18 (5.5)	20 (6.1)	30 (9.1)	40 (12.2)
<i>in.</i>	<i>(mm)</i>	Number of 5-g Calcium Hypochlorite Tablets				
4	(100)	1	1	1	1	1
6	(150)	1	1	1	2	2
8	(200)	1	2	2	3	4
10	(250)	2	3	3	4	5
12	(300)	3	4	4	6	7
16	(400)	4	6	7	10	13

\*Based on 3.25-g available chlorine per tablet; any portion of tablet rounded to next higher integer.

<sup>†</sup>Examples of food-grade adhesives are Permatex Form-A-Gasket No. 2 and Permatex Clear RTV Silicone Adhesive Sealant, which are manufactured by Loctite Corporation, Kansas City, KS 66115. These products have both been approved by the US Drug Administration (USDA) for uses that may involve contact with edible products. Neither product has been approved in accordance with NSF 61. Other company products, such as Permatex Form-A-Gasket No. 1, have not received Fda approval.

#### 7.08.2 Continuous-Feed Method

The continuous-feed method consists of placing calcium hypochlorite granules in the main during construction (optional), completely filling the main to remove all air pockets, flushing the completed main to remove particulates, and filling the main with potable water. The potable water shall be chlorinated so that after a 24-h holding period in the main there will be a free chlorine residual of not less than 10 mg/L.

- A. *Placing of calcium hypochlorite granules.* At the option of the purchaser, calcium hypochlorite granules shall be placed in pipe sections as specified in Section 7.08.1. The purpose of this procedure is to provide a strong chlorine concentration in the first flow of flushing water that flows down the main. In particular, this procedure is recommended when the type of pipe is such that this first flow of water will flow into annular spaces at pipe joints.
- B. *Preliminary flushing.* Before being chlorinated, the main shall be filled to eliminate air pockets and shall be flushed to remove particulates. The flushing velocity in the main shall not be less than 2.5 ft/s (0.76 m/s) unless the purchaser (or purchaser's representative) determines that conditions do not permit the required flow to be discharged to waste. Table 3 shows the rates of flow required to produce a velocity of 2.5 ft/s (0.76 m/s) in commonly used sizes of pipe. Note that flushing is no substitute for preventive measures during construction. Certain contaminants, such as caked deposits, resist flushing at any feasible velocity.

For 24-in. (600-mm) or larger diameter mains, an acceptable alternative to flushing is to broom-sweep the main, carefully removing all sweepings prior to chlorinating the main.

TABLE 3  
Required flow and openings to flush pipelines (40 psi [276 kPa]  
residual pressure in water main)\*

Pipe Diameter		Flow Required to Produce 2.5 ft/s (approx.) Velocity in Main		Size of Tap, in (mm)			Number of 2½-in. (64-mm) Hydrant Outlets
in.	(mm)	gpm	(L/s)	1 (25)	1½ (38)	2(51 mm)	
4	(100)	100	(6.3)	1	-	-	1
6	(150)	200	(12.6)	-	1	-	1
8	(200)	400	(25.2)	-	2	1	1
10	(250)	600	(37.9)	-	3	2	1
12	(300)	900	(56.8)	-	-	2	2
16	(400)	1600	(100.9)	-	-	4	2

\*With a 40-psi (276-kPa) pressure in the main and the hydrant flowing to atmosphere, a 2½-in. (64-mm) hydrant outlet will discharge approximately 1000 gpm (63.1 L/s); and a 4½-in. (114-mm) hydrant outlet will discharge approximately 2500 gpm (160 L/s).

+Number of taps on pipe based on discharge through 5 ft (1.5 m) of galvanized iron (GI) pipe with one 90° elbow.

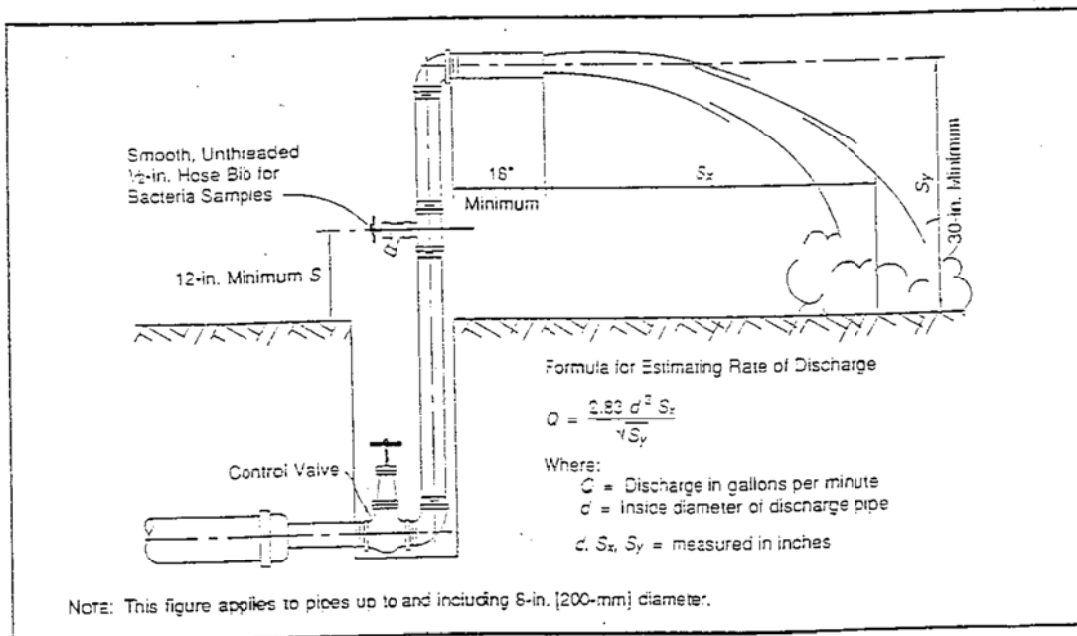

Figure 2. Suggested combination blowoff and sampling tap

C. Procedure for chlorinating the main.

2. Water supplied from a temporary, backflow-protected connection to the

existing distribution system or other approved source of supply shall be made to flow at a constant, measured rate into the newly installed water main. In the absence of a meter, the rate may be approximated by methods such as placing a Pitot gauge in the discharge, measuring the time to fill a container of known volume, or measuring the trajectory of the discharge and using the formula shown in Figure 2.

3. At a point not more than 10 ft (3 m) downstream from the beginning of the new main, water entering the new main shall receive a dose of chlorine fed at a constant rate such that the water will have not less than 25 mg/L free chlorine. To ensure that this concentration is provided, measure the chlorine concentration at regular intervals in accordance with the procedures described in the current edition of *Standard Methods for the Examination of Water and Wastewater* or AWWA Manual M12, or using appropriate chlorine test kits (see appendix A).

Table 4 gives the amount of chlorine required for each 100 ft (30.5 m) of pipe of various diameters. Solutions of 1 percent chlorine may be prepared with sodium hypochlorite or calcium hypochlorite. The latter solution requires 1 lb (454 g) of calcium hypochlorite in 8 gal (30.3 L) of water.

TABLE 4  
Chlorine required to produce 25-mg/L concentration in  
100 ft (30.5 m) of pipe--by diameter

Pipe Diameter		100 percent Chlorine		1 percent Chlorine Solution	
<i>in.</i>	<i>(mm)</i>	<i>Lb</i>	<i>(g)</i>	<i>gal</i>	<i>(L)</i>
4	(100)	.013	(5.9)	.16	(0.6)
6	(150)	.030	(13.6)	.36	(1.4)
8	(200)	.054	(24.5)	.65	(2.5)
10	(250)	.085	(38.6)	1.02	(3.9)
12	(300)	.120	(54.4)	1.44	(5.4)
16	(400)	.217	(98.4)	2.60	(9.8)

4. As an optional procedure (if specified by the purchaser), water used to fill the new main during the application of chlorine shall be supplied through a temporary connection. This temporary connection shall be installed with an appropriate cross-connection control device, consistent with the degree of hazard, for backflow protection of the active distribution system (see Figure 1). Chlorine application shall not cease until the entire main is filled with heavily chlorinated water. The chlorinated water shall be retained in the main for at least 24 h, during which time all valves and hydrants in the treated section shall be operated to ensure disinfection of the appurtenances. At the end of this 24-h period, the treated water in all portions of the main shall have a residual of not less than 10 mg/L free chlorine.
5. Direct-feed chlorinators, which operate solely from gas pressure in the chlorine cylinder, shall not be used for the application of liquid chlorine. (The danger of using direct-feed chlorinators is that water pressure in the



main can exceed gas pressure in the chlorine cylinder. This allows a backflow of water into the cylinder, resulting in severe cylinder corrosion and escape of chlorine gas.) The preferred equipment for applying liquid chlorine is a solution-feed, vacuum-operated chlorinator and a boost pump. The vacuum-operated chlorinator mixes the chlorine gas in solution water; the booster pump injects the chlorine-gas solution into the main to be disinfected. Hypochlorite solutions may be applied to the water main with a gasoline or electrically powered chemical-feed pump designed for feeding chlorine solutions. Feed lines shall be of such material and strength as to safely withstand the corrosion caused by the concentrated chlorine solutions and the maximum pressures that may be created by the pumps. All connections shall be checked for tightness before the solution is applied to the main.

### 7.08.3 Slug Method

The slug method consists of placing calcium hypochlorite granules in the main during construction, completely filling the main to eliminate all air pockets, flushing the main to remove particulates, and slowly flowing through the main a slug of water dosed with chlorine to a concentration of 100 mg/L. The slow rate of flow ensures that all parts of the main and its appurtenances will be exposed to the highly chlorinated water for a period of not less than 3 h.

7.08.3.1 *Placing calcium hypochlorite granules.* Same as Section 7.08.2-A.

7.08.3.2 *Preliminary flushing.* Same as Section 7.08.2-B.

7.08.3.3 *Chlorinating the main.*

- a. Same as Sec. 7.08.2-C.
- b. At a point not more than 10 ft (3 m) downstream from the beginning of the new main, water entering the new main shall receive a dose of chlorine fed at a constant rate such that the water will have not less than 100 mg/L free chlorine. To ensure that this concentration is achieved, the chlorine concentration should be measured at regular intervals. The chlorine shall be applied continuously and for a sufficient period to develop a solid column, or "slug", of chlorinated water that will, as it moves through the main, expose all interior surfaces to a concentration of approximately 100 mg/L for at least 3 h.
- c. The free chlorine residual shall be measured in the slug as it moves through the main. If at any time it drops below 50 mg/L, the flow shall be stopped, chlorination equipment shall be relocated at the head of the slug, and as flow is resumed, chlorine shall be applied to restore the free chlorine in the slug to not less than 100 mg/L.
- d. As the chlorinated water flows past fittings and valves, related valves and hydrants shall be operated so as to disinfect appurtenances and pipe branches.

## 7.09 FINAL FLUSHING

7.09.1 Clearing the Main of Heavily Chlorinated Water

---

WATER MAIN DISTRIBUTION SPECIFICATIONS  
2000-31

---

After the applicable retention period, heavily chlorinated water should not remain in prolonged contact with pipe. In order to prevent damage to the pipe lining or corrosion damage to the pipe itself, the heavily chlorinated water shall be flushed from the main until chlorine measurements show that the concentration in the water leaving the main is no higher than that generally prevailing in the distribution system or is acceptable for domestic use.

#### 7.09.2 Disposing of Heavily Chlorinated Water

The environment into which the chlorinated water is to be discharged shall be inspected. If there is any possibility that the chlorinated discharge will cause damage to the environment, then a neutralizing chemical shall be applied to the water to be wasted to neutralize thoroughly the chlorine residual remaining in the water. (See appendix B for neutralizing chemicals.) Where necessary, federal, state, provincial, and local regulatory agencies should be contacted to determine special provisions for the disposal of heavily chlorinated water.

### 7.10 BACTERIOLOGICAL TESTS

#### 7.10.1 Standard Conditions

After final flushing and before the new water main is connected to the distribution system, two consecutive sets of acceptable samples, taken at least 24 h apart, shall be collected from the new main. At least one set of samples shall be collected from every 1200 ft (366 m) of the new water main, plus one set from the end of the line and at least one set from each branch. All samples shall be tested for bacteriological quality in accordance with *Standard Methods for the Examination of Water and Wastewater*, and shall show the absence of coliform organisms. A standard heterotrophic plate count may be required at the option of the purchaser (or purchaser's representative).

#### 7.10.2 Special Conditions

If trench water has entered the new main during construction or, if in the opinion of the purchaser (or purchaser's representative), excessive quantities of dirt or debris have entered the new main, bacteriological samples shall be taken at intervals or approximately 200 ft (61 m) and shall be identified by location. Samples shall be taken of water that has stood in the new main for at least 16 h after final flushing has been completed.

#### 7.10.3 Sampling Procedure

All samples must be collected by a Certified Water Operator in the State of Nebraska by Health and Human Services, Grade V or higher. An owners representative must be on site during all sampling procedures. Samples for bacteriological analysis shall be collected in sterile bottles treated with sodium thiosulfate as required by *Standard Methods for the Examination of Water and Wastewater*. No hose or fire hydrant shall be used in the collection of samples. A suggested combination blowoff and sampling tap useful for mains up to and including 8-in. (200-mm) diameter is shown in Figure 2. A corporation cock must be installed in the main with a copper-tube gooseneck assembly. After samples have been collected, the gooseneck assembly may be removed and retained for future use.

### **7.11 REDISINFECTION**

If the initial disinfection fails to produce satisfactory bacteriological results, the new main may be reflushed and shall be resampled. If check samples also fail to produce acceptable results, the main shall be rechlorinated by the continuous-feed or slug methods of chlorination until satisfactory results are obtained. The contract will allow time for one check sample. If the initial check sample fails, future sampling procedures and related work may be subject to liquidated damages per the contract.

### **7.12 FINAL CONNECTIONS TO EXISTING MAINS (Optional)<sup>1</sup>**

As an optional procedure (if specified by the purchaser), water mains and appurtenances must be completely installed, flushed, disinfected, and satisfactory bacteriological sample results received prior to permanent connections being made to the active distribution system. Sanitary construction practices must be followed during installation of the final connection, so that there is no contamination of the new or existing water main with foreign material or groundwater.

---

<sup>1</sup>Optional Section 7.12 is not included as part of the standard unless specifically identified in the purchaser's specifications.

#### **7.12.1 Connections Equal To or Less Than One Pipe Length ( $\leq$ 18 ft [5.5 m])**

As an optional procedure (if specified by the purchaser), the new pipe, fittings, and valve(s) required for the connection may be spray-disinfected or swabbed with a minimum 1 percent solution of chlorine just prior to being installed, if the total length of connection from the end of a new main to the existing main is equal to or less than 18 ft (5.5 m).

#### **7.12.2 Connections Greater Than One Pipe Length ( $>$ 18 ft [5.5 m])**

As an optional procedure (if specified by the purchaser), the pipe required for the connection must be set up aboveground, disinfected, and bacteriological samples taken, as described in Section 7.08 through Section 7.11, if the total length of connection from the end of a new main to the existing main is greater than 18 ft (5.5 m). After satisfactory bacteriological sample results have been received for this "pre-disinfected" pipe, the pipe can be used in connecting the new main to the active distribution system. Between the time that satisfactory bacteriological sample results are received and the time that the connection piping is installed, the ends of this piping must be sealed with plastic wraps or watertight plugs or caps.

### **7.13 DISINFECTION PROCEDURES WHEN CUTTING INTO OR REPAIRING EXISTING MAINS**

The following procedures apply primarily when existing mains are wholly or partially dewatered. After the appropriate procedures have been completed, the existing main may be returned to service prior to completion of bacteriological testing in order to minimize the time customers are out of water. Leaks or breaks that are repaired with clamping devices while the mains remain full of pressurized water present little danger of contamination and require no disinfection.

#### **7.13.1 Trench Treatment**

When an existing main is opened, either by accident or by design, the excavation will likely be wet and may be badly contaminated from nearby sewers. Liberal quantities of hypochlorite applied to open trench areas will lessen the danger from such pollution. Tablets have the advantage in such a situation because they dissolve slowly and continue to release hypochlorite as water is pumped from the excavation.

#### 7.13.2 Swabbing With Hypochlorite Solution

The interior of all pipe and fittings (particularly couplings and sleeves) used in making the repair shall be swabbed or sprayed with a 1 percent hypochlorite solution before they are installed.

#### 7.13.3 Flushing

Thorough flushing is the most practical means of removing contamination introduced during repairs. If valve and hydrant locations permit, flushing toward the work location from both directions is recommended. Flushing shall be started as soon as the repairs are completed and shall be continued until discolored water is eliminated.

#### 7.13.4 Slug Chlorination

When practical, in addition to the procedures above, the section of main in which the break is located shall be isolated, all service connections shut off, and the section flushed and chlorinated as described in Section 7.08.3, except that the dose may be increased to as much as 300 mg/L and the contact time reduced to as little as 15 min. After chlorination, flushing shall be resumed and continued until discolored water is eliminated, and the water is free of noticeable chlorine odor.

#### 7.13.5 Sampling

Bacteriological samples shall be taken after repairs are completed to provide a record for determining the procedure's effectiveness. If the direction of flow is unknown, then samples shall be taken on each side of the main break. If positive bacteriological samples are recorded, then the situation shall be evaluated by the purchaser (or purchaser's representative) who can determine corrective action, and daily sampling shall be continued until two consecutive negative samples are recorded.

### **7.14 SPECIAL PROCEDURES FOR CAULKED TAPPING SLEEVES**

Before a tapping sleeve is installed, the exterior of the main to be tapped shall be thoroughly cleaned, and the interior surface of the sleeve shall be lightly dusted with calcium hypochlorite powder.

Tapping sleeves are used to avoid shutting down the main to be tapped. After the tap is made, it is impossible to disinfect the annulus without shutting down the main and removing the sleeve. The space between the tapping sleeve and the tapped pipe is normally ½ in. (13 mm), more or less, so that as little as 100 mg/ft<sup>2</sup> of calcium hypochlorite powder will provide a chlorine concentration of over 50 mg/L.

## APPENDIX A

### Chlorine Residual Testing

*This appendix is for information only and is not a part of AWWA C651.*

#### SECTION A.1: DPD DROP DILUTION METHOD (FOR FIELD TEST)

The DPD drop dilution method of approximating total residual chlorine is suitable for concentrations above 10 mg/L, such as are applied in the disinfection of water mains or tanks.

##### Section A.1.1. Apparatus

1. A graduated cylinder for measuring distilled water.
2. An automatic or safety pipette.
3. Two dropping pipettes that deliver a 1-mL sample in 20 drops. One pipette is for dispensing the water sample, and the other is for dispensing the DPD and buffer solutions. The pipettes should not be interchanged.
4. A comparator kit containing a suitable range of standards.

##### Section A.1.2 Reagents

1. DPD indicated solution. Prepare as prescribed in *Standard Methods for the Examination of Water and Wastewater* (18th ed.), Section 4500-Cl G, p 4-62.

##### Section A.1.3 Procedure

1. Add 10 drops of DPD solution and 10 drops of buffer solution (or 20 drops of combined DPD-buffer solution) to a comparator cell.
2. Fill the comparator cell to the 10-mL mark with distilled water.
3. With a dropping pipette, add the water sample one drop at a time, allowing mixing, until a red color is formed that matches one of the color standards.
4. Record the total number of drops used and the final chlorine reading obtained (that is, the chlorine reading of the matched standard).
5. Calculate the milligrams per liter of free residual chlorine as follows:

$$\text{mg/L chlorine} = \frac{\text{reading} \times 200}{\text{drops of sample}}$$

#### SECTION A.2: HIGH-RANGE CHLORINE TEST KITS

Several manufacturers produce high-range chlorine test kits that are inexpensive, easy to use, and satisfactory for the precision required.

**APPENDIX B**

Disposal of Heavily Chlorinated Water

*This appendix is for information only and is not a part of AWWA C651.*

1. Check with the local sewer department for conditions of disposal to sanitary sewer.
2. Chlorine residual of water being disposed will be neutralized by treating with one of the chemicals listed in Table B.1.

Table B.1  
Amounts of chemicals required to neutralize residual chlorine concentrations  
in 100,000 gal (378.5 m<sup>3</sup>) of water

Residual Chlorine Concentration	Chemical Required							
	Sulfur Dioxide (SO <sub>x</sub> )		Sodium Bisulfite (NaHSO <sub>3</sub> )		Sodium Sulfite (Na <sub>2</sub> SO <sub>3</sub> )		Sodium Thiosulfate (Na <sub>2</sub> S <sub>x</sub> O <sub>3</sub> · 5H <sub>2</sub> O)	
	mg/L	lb	(kg)	Lb	(kg)	lb	(kg)	lb
1	0.8	(.36)	1.2	(.54)	1.4	(.64)	1.2	(.54)
2	1.7	(.77)	2.5	(1.13)	2.9	(1.32)	2.4	(1.09)
10	8.3	(3.76)	12.5	(5.67)	14.6	(6.62)	12.0	(5.44)
50	41.7	(18.91)	62.6	(28.39)	73.0	(33.11)	60.0	(27.22)

**END OF SECTION**

## MAINTENANCE

### 1. PERIOD

The maintenance period of drains, manholes, inlets, pavement, curbs, gutters and all parts of this project shall extend for one (1) year after the date of acceptance, except that if the date of acceptance falls between November 1 and the following March 31, the maintenance period shall extend for one (1) full year after March 31.

### 2. TIMING

Approximately 30 days before the end of the maintenance period, or at the request of the Owner at any time prior to that date, if it appears that any hazard exists or excessive damage is being done because of lack of maintenance, the Contractor shall examine all construction and during the time remaining prior to expiration of the guarantee period, he shall repair, without expense to the Owner, such defects as may have developed.

### 3. WATER WORKS

Water main, fittings, valves, etc., that are found to leak or be defective during the maintenance warranty period shall be repaired by the contractor at no cost to the owner. Repairs to all features damaged by the leaks or defects shall be the responsibility of the contractor.

Trench settlement by any reason shall be repaired by the contractor as well as any damage caused by the settlement.

### 4. RESPONSIBILITY FOR MAINTENANCE

The entire responsibility for the above described maintenance rests with the contractor and his construction and maintenance bond, or a separate maintenance bond if he prefers to supply one, provided the specifications and all contract documents of this project have been satisfied.

Maintenance  
2900-1

# simply smart solutions

[www.mcschaff.com](http://www.mcschaff.com)



**M.C. SCHAFF**  
AND ASSOCIATES, INC.

**PGE** PANHANDLE  
GEOTECHNICAL &  
ENVIRONMENTAL



ENVIRO SERVICE



# WATER DISTRICT 105 BLOCK 2, REGANIS SUBDIVISION AND BLOCK 1A, SCOTTS BLUFF COUNTY COLLEGE TRACT SCOTTSBLUFF, NEBRASKA

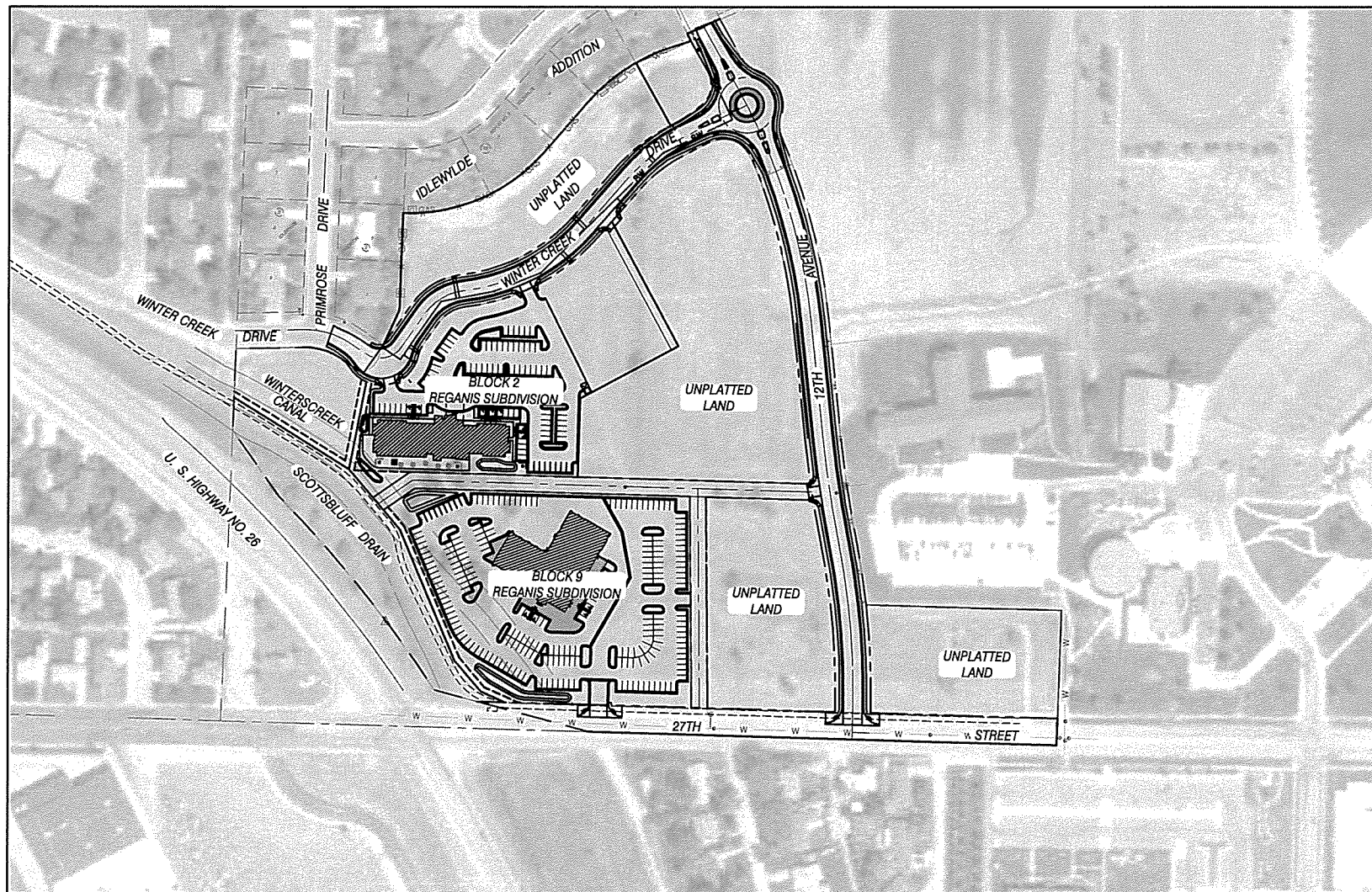

**SHEET INDEX**

DRAWING	SHEET	DRAWING
G-1	1	COVER SHEET
LEG-1	2	LEGEND/SUMMARY OF QTYS.
I-1	3	INDEX SHEET
W-1 - W-3	4-6	PLAN & PROFILE SHEETS
D-1 - D-2	7-8	DETAIL SHEETS

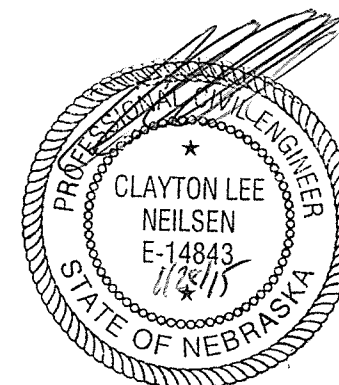

**M. C. SCHAFF AND ASSOCIATES, INC.**  
**818 SOUTH BELTLINE HIGHWAY EAST**  
**SCOTTSBLUFF, NEBRASKA 69361**

ENGINEERS ♦ PLANNERS ♦ DESIGNERS ♦ LAND SURVEYORS  
 PH: 308-635-1926 FAX: 308-635-7807 INTERNET: WWW.MCSCHAFF.COM

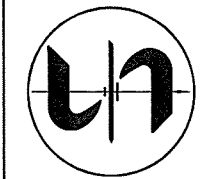

**LEGEND**

SYMBOL	EXISTING	PROPOSED
PROPERTY CORNER		
RIGHT OF WAY MARKER		
STOP SIGN		
ROAD SIGN		
DELINEATOR		
BOLLARD		
MAILBOX		
FIRE HYDRANT		
VALVE		
CURB STOP		
METER PIT		
MANHOLE		
STORM INLET		
POWER POLE		
LIGHT POLE		
GUY WIRE		
ELECTRIC TRANSFORMER		
TRAFFIC SIGNAL W/ LUMINARY		
TELEPHONE PEDESTAL		
TELEPHONE MARKER		
GAS MARKER		
CABLE TV PEDESTAL		
DECIDUOUS TREE		
CONIFER		
MONITORING WELL		

**LEGEND**

SYMBOL	EXISTING	PROPOSED
RIGHT OF WAY		
CENTERLINE		
WATER MAIN		
6" WATER MAIN		
8" WATER MAIN		
12" WATER MAIN		
1" WATER SERVICE LINE		
2" WATER SERVICE LINE		
4" NONPOTABLE MAIN		
8" SANITARY SEWER		
12" SANITARY SEWER		
15" SANITARY SEWER		
STORM DRAIN		
IRRIGATION LATERAL		
OVERHEAD ELECTRIC		
UNDERGROUND ELECTRIC		
UNDERGROUND TELEPHONE		
UNDERGROUND CABLE TV		
UNDERGROUND FIBER OPTIC		
GAS MAIN		
FENCE		
EDGE OF PAVEMENT		
CURB AND GUTTER		
CONSTRUCTION LIMITS		

**ABBREVIATIONS**

ADA	AMERICANS WITH DISABILITIES ACT
AUX	AUXILIARY
BB	BACK TO BACK
BDC	BEGIN DROP CURB
BL	BURY LINE
BOP	BEGINNING OF PROJECT
C/L	CENTERLINE
CMP	CORRUGATED METAL PIPE
CY	CUBIC YARDS
D	DEGREE OF CURVATURE
DC	TOP OF DROP CURB
DIA	DIAMETER
E	EAST, EASTING
EA	EACH
EDC	END DROP CURB
EL,ELEV	ELEVATION
FES	FLARED END SECTION
FL	FLOW LINE
FT	FEET, FOOT
HOR	HORIZONTAL
IE	INVERT ELEVATION
LBS	POUNDS
LF	LINEAL FEET
LIN	LINEAL
LT	LEFT
MAX	MAXIMUM
MIN	MINIMUM
N	NORTH, NORTHING
OC	ON CENTER
OFF	OFFSET
P.C.	PORTLAND CEMENT
PC	POINT OF CURVATURE
PI	POINT OF INTERSECTION
PREP	PREPARATION
PT	POINT OF TANGENCY
PVC	POLYVINYL CHLORIDE
R,RAD	RADIUS
RCCP	REINFORCED CONCRETE CULVERT PIPE
RE:	REFERENCE
REINF	REINFORCE, REINFORCING
RGSV	RESILIENT SEATED GATE VALVE
ROW	RIGHT OF WAY
RT	RIGHT
SQ	SQUARE
STA	STATION
SY	SQUARE YARDS
T	TANGENT
TC	TOP OF CURB
TEMP	TEMPORARY
TP	TOP OF PAVEMENT
TW	TOP OF SIDEWALK
TYP	TYPICAL
VER	VERTICAL
VO	VERTICAL OPERATING
VPI	VERTICAL POINT OF INTERSECTION
YDS	YARDS

**GENERAL NOTES**

THE CONTRACTOR IS RESPONSIBLE FOR OBTAINING ALL REQUIRED PERMITS PRIOR TO COMMENCEMENT OF ANY WORK ON THE PROJECT.

IT IS THE CONTRACTOR'S RESPONSIBILITY TO NOTIFY THE ENGINEER OF ANY PROBLEMS IN CONFORMING TO THE APPROVED PLANS FOR ANY ELEMENT OF THE PROPOSED IMPROVEMENTS PRIOR TO ITS CONSTRUCTION.

IT IS THE RESPONSIBILITY OF THE ENGINEER DURING CONSTRUCTION ACTIVITIES TO RESOLVE CONSTRUCTION PROBLEMS DUE TO CHANGED CONDITIONS, OR DESIGN ERRORS ENCOUNTERED BY THE CONTRACTOR DURING THE PROGRESS OF ANY PORTION OF THE PROJECT. IF, IN THE OPINION OF THE CITY, THE MODIFICATIONS PROPOSED BY THE ENGINEER, TO THE APPROVED PLANS, INVOLVE SIGNIFICANT CHANGES TO THE CHARACTER OF THE WORK, OR TO THE FUTURE CONTIGUOUS PUBLIC OR PRIVATE IMPROVEMENTS, THE ENGINEER SHALL BE RESPONSIBLE FOR RESUBMITTING THE REVISED PLANS TO THE CITY OF SCOTTSBLUFF FOR APPROVAL PRIOR TO ANY FURTHER CONSTRUCTION RELATED TO THAT PORTION OF THE PROJECT. ANY IMPROVEMENTS NOT CONSTRUCTED IN ACCORDANCE WITH THE APPROVED PLANS, OR THE APPROVED REVISED PLANS, SHALL BE REMOVED AND RECONSTRUCTED ACCORDING TO THE APPROVED PLANS.

ANY CONSTRUCTION DEBRIS OR MUD TRACKING ONTO THE PUBLIC RIGHT OF WAY, RESULTING FROM THE PROJECT, SHALL BE REMOVED IMMEDIATELY, BY THE CONTRACTOR. THE CONTRACTOR SHALL IMMEDIATELY FIX ANY EXCAVATION, OR EXCESSIVE PAVEMENT FAILURE CAUSED BY THE FAILURE, AND SHALL PROPERLY BARRICADE THE SITE UNTIL CONSTRUCTION IS COMPLETE. FAILURE BY THE CONTRACTOR, TO CORRECT ANY OF THE ABOVE WITHIN 48 HOURS OF WRITTEN NOTICE, BY THE CITY, SHALL CAUSE THE CITY TO ISSUE A STOP WORK ORDER (RED TAG) AND/OR DO THE WORK AND MAKE A CLAIM AGAINST THE PROJECTS LETTER OF CREDIT FOR ANY COSTS INCURRED BY THE CITY OF SCOTTSBLUFF.

THE CONTRACTOR SHALL BE SOLELY, AND COMPLETELY RESPONSIBLE FOR THE CONDITIONS AT, AND ADJACENT TO THE JOB SITE, INCLUDING THE SAFETY OF ALL PERSONS AND PROPERTY, DURING THE PERFORMANCE OF THE WORK, THIS REQUIREMENT SHALL APPLY CONTINUOUSLY, AND SHALL NOT BE LIMITED TO NORMAL WORKING HOURS, THE DUTY OF THE CITY TO CONDUCT CONSTRUCTION REVIEW OF THE CONTRACTOR'S PERFORMANCE IS NOT INTENDED TO INCLUDE THE ADEQUACY OF THE CONTRACTOR'S SAFETY MEASURES IN, ON OR NEAR THE CONSTRUCTION SITE.

THE CONTRACTOR SHALL BE RESPONSIBLE FOR OBTAINING UTILITY LOCATIONS AT LEAST 48 HOURS (2 BUSINESS DAYS) PRIOR TO THE COMMENCEMENT OF ANY CONSTRUCTION. FOR INFORMATION CONTACT DIGGERS HOTLINE: 1-800-331-5666. THE CONTRACTOR SHALL FIELD VERIFY SIZE, HORIZONTAL AND VERTICAL LOCATIONS OF EXISTING FACILITIES PRIOR TO ANY CONSTRUCTION AND NOTIFY THE ENGINEER OF ANY DISCREPANCIES.

THE CONTRACTOR SHALL PROVIDE ALL LIGHTS, SIGNS, BARRICADES, FLAG PERSONS OR OTHER DEVICES NECESSARY TO PROVIDE FOR THE PUBLIC SAFETY IN ACCORDANCE WITH THE CURRENT MANUAL ON UNIFORM TRAFFIC CONTROL DEVICES.

THE CONTRACTOR SHALL NOTIFY THE INSPECTOR AND TESTING AGENCY AT LEAST 24 HOURS PRIOR TO THE DESIRED INSPECTION.

ALL TRENCHES SHALL BE ADEQUATELY SUPPORTED AND THE SAFETY OF WORKERS PROVIDED FOR AS REQUIRED BY THE MOST RECENT OCCUPATIONAL SAFETY AND HEALTH ADMINISTRATION (OSHA) SAFETY AND HEALTH REGULATIONS FOR CONSTRUCTION. THESE REGULATIONS ARE DESCRIBED IN SUBPART P., PART 1926 OF THE CODE OF FEDERAL REGULATIONS, UTILIZE SHEETING AND SHORING WHERE REQUIRED TO PREVENT ANY EXCESSIVE WIDENING OR SLOUGHING OF THE TRENCH WHICH MAY BE DETRIMENTAL TO HUMAN SAFETY, TO THE PIPE BEING PLACED, TO TREES, OR TO ANY EXISTING STRUCTURE, WHERE EXCAVATIONS ARE MADE UNDER SEVERE WATER CONDITIONS, THE CONTRACTOR MAY BE REQUIRED TO USE AN APPROVED PILING INSTEAD OF SHEETING AND SHORING. EXCAVATED MATERIAL SHALL NOT BE PLACED NEARER THAN 2 FEET FROM THE SIDES OF THE TRENCH. HEAVY EQUIPMENT SHALL NOT BE PLACED NEAR THE SIDES OF THE TRENCH UNLESS THE TRENCH IS ADEQUATELY BRACED.

COMPACTION OF ALL TRENCHES AND ANY OTHER REQUIRED AREAS MUST BE ATTAINED AND THE TEST RESULTS SUBMITTED TO THE ENGINEER AND THE OWNER PRIOR TO ACCEPTANCE.

THE CONTRACTOR SHALL HAVE IN HIS/HER POSSESSION AT ALL TIMES AT LEAST ONE COPY OF THE PLANS APPROVED BY THE CITY OF SCOTTSBLUFF.

THE CONTRACTOR SHALL NOTIFY THE OWNER AT LEAST 48 HOURS PRIOR TO THE START OF ANY CONSTRUCTION.

THE CONTRACTOR IS RESPONSIBLE FOR IMPLEMENTING AND MAINTAINING DUST CONTROL MEASURES AT ALL TIMES DURING CONSTRUCTION.

DETECTOR WIRE IS REQUIRED FOR THIS PROJECT FOR ALL WATER MAINS AND SERVICES LINES.

THE CITY SHALL OPERATE ALL VALVES FOR THE CONSTRUCTION OF THIS PROJECT.

THE CONTRACTOR SHALL NOT CONNECT TO THE EXISTING WATER MAINS UNTIL THE CITY GRANTS PERMISSION TO DO SO.

THE CONTRACTOR SHALL FIELD VERIFY THE LOCATION AND DEPTH OF CONNECTIONS MADE TO THE EXISTING SYSTEM AND THE CONNECTION TO THE EXISTING SERVICES BEFORE CONSTRUCTION BEGINS.

NO PORTION OF THE NEW WATER SYSTEM SHALL BE PLACED IN SERVICE UNTIL APPROVED BY THE ENGINEER AND NHHSS.

THE CONTRACTOR SHALL MAINTAIN ACCESS TO ALL PROPERTIES DURING THE CONSTRUCTION OF THIS PROJECT.

**QUANTITIES - WATER DISTRICT 105 - REGANIS SUBDIVISION & BLOCK 1A COLLEGE TRACT (CITY OF SCOTTSBLUFF)**

ITEM	DESCRIPTION	ESTIMATED QUANTITY	FINAL QUANTITY
1	MOBILIZATION	1 LUMP SUM	LUMP SUM
2	8" PVC WATER LINE	1,000 L.F.	L.F.
3	6" PVC WATER LINE	120 L.F.	L.F.
4	8" WATER VALVE AND VALVE BOX	2 EA.	EA.
5	FIRE HYDRANT W/ 6" AUXILIARY VALVE & VALVE BOX	2 EA.	EA.
6	REMOVE & RESET FIRE HYDRANT W/ NEW 6" AUXILIARY VALVE & VALVE BOX	1 EA.	EA.
7	3" SERVICE CONNECTION	1 EA.	EA.
8	2" SERVICE CONNECTION	2 EA.	EA.
9	1" SERVICE CONNECTION	7 EA.	EA.
10	3" SERVICE LINE	30 L.F.	L.F.
11	2" SERVICE LINE	50 L.F.	L.F.
12	1" SERVICE LINE	280 L.F.	L.F.
13	FITTINGS	1,800 LBS.	LBS.
14	LOCATOR BALL	30 EA.	EA.

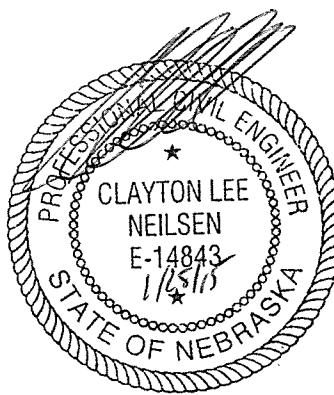

**GENERAL DESIGN PARAMETERS**

DESIGN PRESSURE: 65 PSI

DEPTH OF BURY: 5.5' MINIMUM

INSTALLATION STANDARD: AWWA STANDARD SPECIFICATIONS C605 INSTALLATION OF PVC PIPE.

DESIGN STANDARDS: STATE OF NEBRASKA TITLE 179 NAC 7 & RECOMMENDED STANDARDS FOR WATER WORKS, 2007 EDITION.

**M. C. SCHAFF & ASSOCIATES, INC.**  
818 SOUTH BELTLINE HIGHWAY EAST  
SCOTTSBLUFF, NEBRASKA 69361



ENGINEERS ♦ PLANNERS ♦ DESIGNERS ♦ LAND SURVEYORS  
PH: 308-695-1926 FAX: 308-695-7807 INTERNET: WWW.MCSCHAFF.COM

**PROJECT: WATER DISTRICT 105**  
**BLOCK 2, REGANIS SUBDIVISION**  
**AND BLOCK 1A, SCOTTS BLUFF**  
**COUNTY COLLEGE TRACT.**  
**LEGEND/SUMMARY OF**  
**QUANTITIES**

**CLIENT: CITY OF SCOTTSBLUFF**

PROJECT NUMBER: RM 140169-00
PROJECT DATE: 01-28-15
PROJECT MGR: C.L.N.
PROJECT TEAM: C.L.N./W.W.

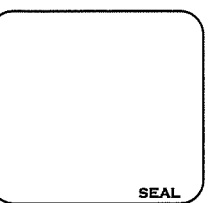

DATE	REVISION

SHEET 2 OF 8  
**LEG-1**

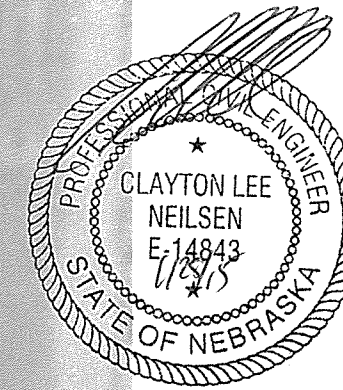

**M. C. SCHAFF & ASSOCIATES, INC.**  
**818 SOUTH BELTLINE HIGHWAY EAST**  
**SCOTTSBUFF, NEBRASKA 69361**

ENGINEERS ♦ PLANNERS ♦ DESIGNERS ♦ LAND SURVEYORS  
 PH: 308-635-1926 FAX: 308-635-7807 INTERNET: WWW.MCSCHAFF.COM

**PROJECT: WATER DISTRICT 105**  
**BLOCK 2, REGANIS SUBDIVISION**  
**AND BLOCK 1A, SCOTTSBUFF**  
**COUNTY COLLEGE TRACT.**  
**INDEX SHEET**

**CLIENT: CITY OF SCOTTSBUFF**

PROJECT NUMBER:  
 RM 140169-00  
 PROJECT DATE:  
 01-28-15  
 PROJECT MGR:  
 C.L.N.  
 PROJECT TEAM:  
 C.L.N./W.W.

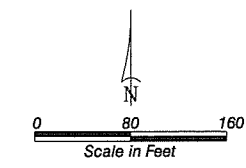

SEAL

DATE	REVISION

CALL BEFORE YOU DIG  
 BIGGER'S HOTLINE  
 811 or  
 1-800-331-5666  
 WWW.B-DIGGERS.COM  
 CALL 2 BUSINESS DAYS  
 PRIOR TO ALL WORK

SHEET 3 OF 8  
**11**

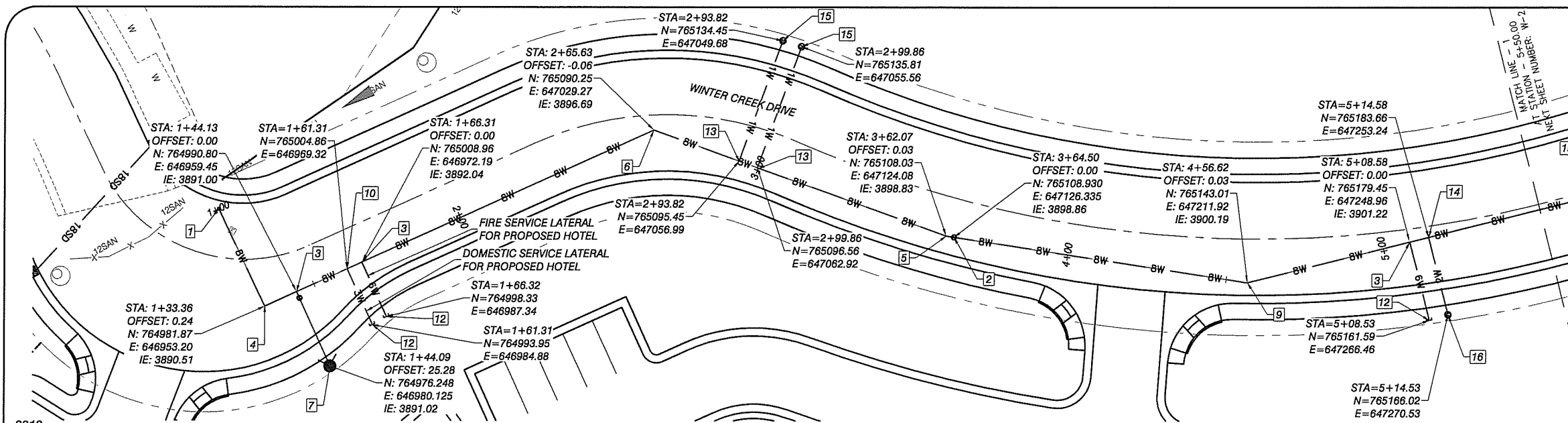

- WATER CONSTRUCTION NOTES:**  
 (NOTE: NOT ALL NOTES ARE USED ON THIS SHEET)
- 1 CONNECT NEW 8" WATERLINE TO EXIST 8" WATERLINE
  - 2 INSTALL 8" GATE VALVE AND VALVE BOX
  - 3 INSTALL 8"x6" TEE
  - 4 INSTALL 8" 90 DEG. HORIZONTAL BEND
  - 5 INSTALL 8" 11.25 DEG. HORIZONTAL BEND
  - 6 INSTALL 8" 45 DEG. HORIZONTAL BEND
  - 7 INSTALL NEW FIRE HYDRANT W/ AUX. VALVE AND VALVE BOX
  - 8 INSTALL RELOCATED FIRE HYDRANT WITH NEW AUX. VALVE AND VALVE BOX
  - 9 INSTALL 8" 22.5 DEG. HORIZONTAL BEND
  - 10 INSTALL 3" SERVICE SADDLE
  - 11 REMOVE & RELOCATE EXISTING FIRE HYDRANT. INSTALL 8"x6" REDUCER
  - 12 CUT & CAP SERVICE LATERAL
  - 13 INSTALL 1" SERVICE SADDLE
  - 14 INSTALL 2" SERVICE SADDLE
  - 15 INSTALL 1" CURB STOP
  - 16 INSTALL 2" CURB STOP

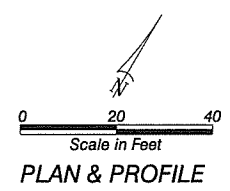
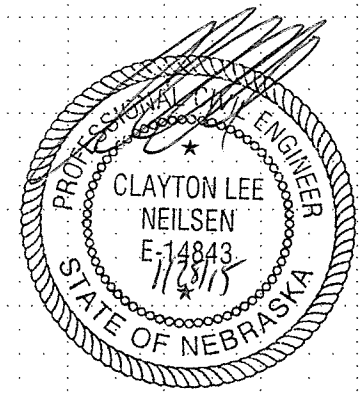
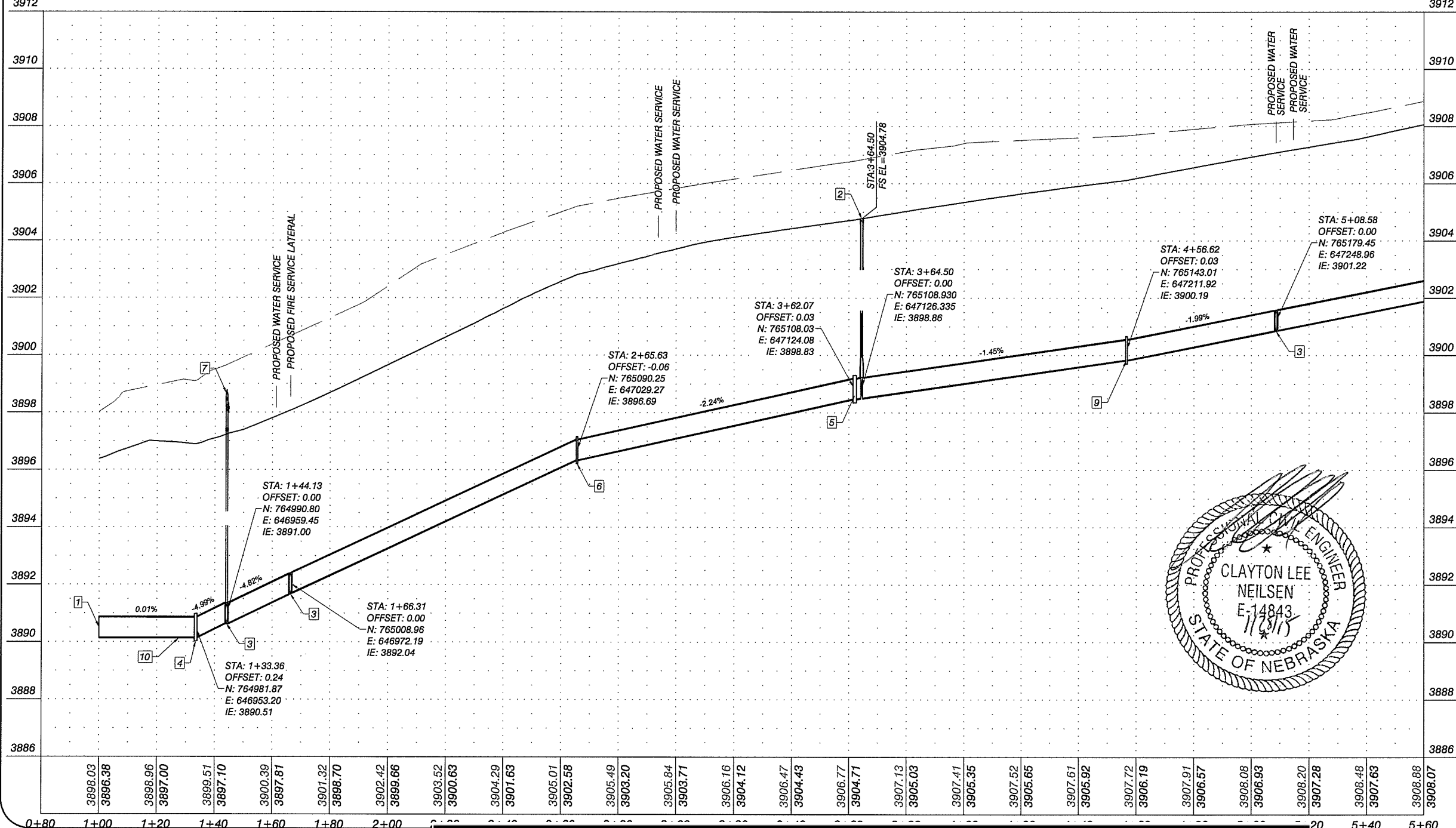

PLAN & PROFILE

CALL BEFORE YOU DIG  
 DIGGER'S HOTLINE  
 811 or  
 1-800-331-5666  
 WWW.NE-DIGGERS.COM  
 CALL 2 BUSINESS DAYS  
 PRIOR TO ALL WORK

**M. C. SCHAFF & ASSOCIATES, INC.**  
 818 SOUTH BELTLINE HIGHWAY EAST  
 SCOTTSBLUFF, NEBRASKA 69361

ENGINEERS ♦ PLANNERS ♦ DESIGNERS ♦ LAND SURVEYORS  
 PH: 308-635-1926 FAX: 308-635-7807 INTERNET: WWW.MCSCHAFF.COM

**PROJECT:** WATER DISTRICT 105  
 BLOCK 2, REGANIS SUBDIVISION  
 AND BLOCK 1A, SCOTTS BLUFF  
 COUNTY COLLEGE TRACT.  
 PLAN & PROFILE SHEET

**CLIENT:** CITY OF SCOTTSBLUFF

**PROJECT NUMBER:**  
 RM 140169-00

**PROJECT DATE:**  
 01-28-15

**PROJECT MGR:**  
 C.L.N.

**PROJECT TEAM:**  
 C.L.N./W.W.

SEAL

DATE	REVISION

**SHEET 4 OF 8**  
**W-1**

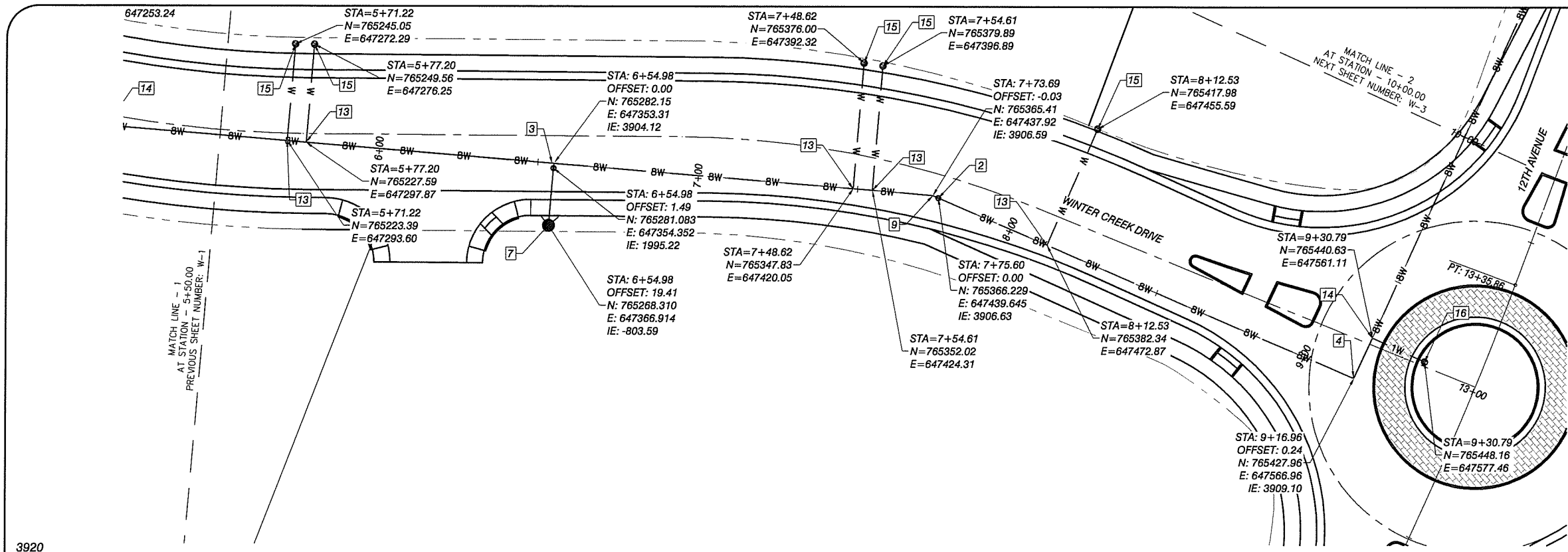

- WATER CONSTRUCTION NOTES:**  
 (NOTE: NOT ALL NOTES ARE USED ON THIS SHEET)
- CONNECT NEW 8" WATERLINE TO EXIST 8" WATERLINE
  - INSTALL 8" GATE VALVE AND VALVE BOX
  - INSTALL 8"x6" TEE
  - INSTALL 8" 90 DEG. HORIZONTAL BEND
  - INSTALL 8" 11.25 DEG. HORIZONTAL BEND
  - INSTALL 8" 45 DEG. HORIZONTAL BEND
  - INSTALL NEW FIRE HYDRANT W/ AUX. VALVE AND VALVE BOX
  - INSTALL RELOCATED FIRE HYDRANT WITH NEW AUX. VALVE AND VALVE BOX
  - INSTALL 8" 22.5 DEG. HORIZONTAL BEND
  - INSTALL 3" SERVICE SADDLE
  - REMOVE & RELOCATE EXISTING FIRE HYDRANT. INSTALL 8"x6" REDUCER
  - CUT & CAP SERVICE LATERAL
  - INSTALL 1" SERVICE SADDLE
  - INSTALL 2" SERVICE SADDLE
  - INSTALL 1" CURB STOP
  - INSTALL 2" CURB STOP

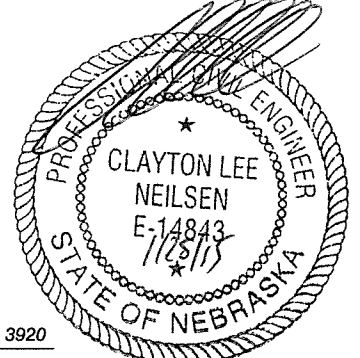

**M. C. SCHAFF & ASSOCIATES, INC.**  
 818 SOUTH BELTLINE HIGHWAY EAST  
 SCOTTSBLUFF, NEBRASKA 69361

ENGINEERS ♦ PLANNERS ♦ DESIGNERS ♦ LAND SURVEYORS  
 PH: 308-635-1926 FAX: 308-695-7807 INTERNET: WWW.MCSCHAFF.COM

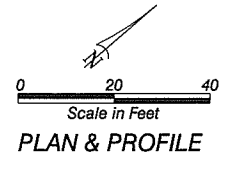
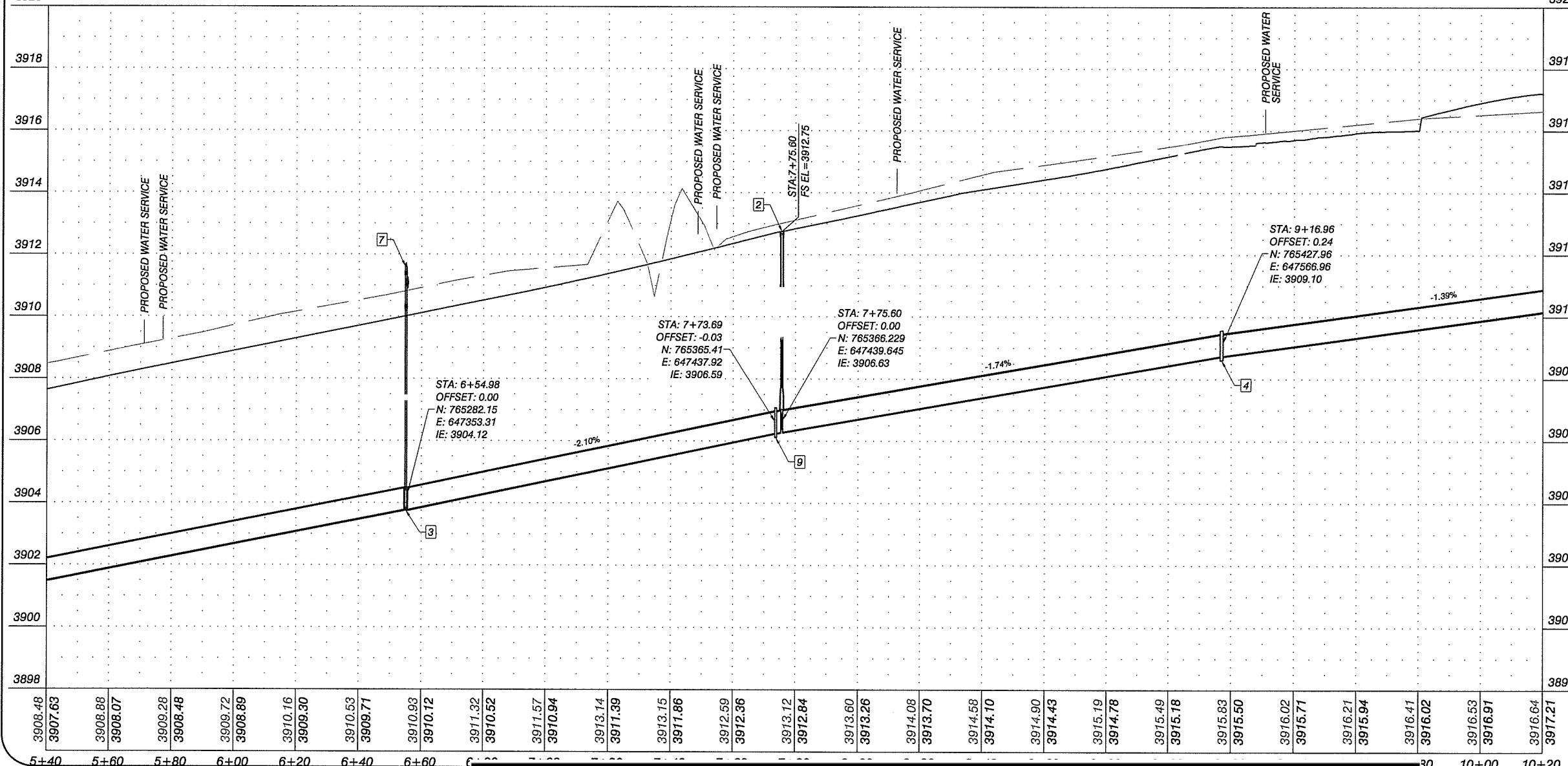

**PROJECT:** WATER DISTRICT 105  
 BLOCK 2, REGANIS SUBDIVISION  
 AND BLOCK 1A, SCOTTS BLUFF  
 COUNTY COLLEGE TRACT.  
 PLAN & PROFILE SHEET

**CLIENT:** CITY OF SCOTTSBLUFF

**PROJECT NUMBER:**  
 RM 140169-00

**PROJECT DATE:**  
 01-28-15

**PROJECT MGR:**  
 C.L.N.

**PROJECT TEAM:**  
 C.L.N./W.W.

SEAL	
DATE	REVISION

CALL BEFORE YOU DIG  
 DIGGER'S HOTLINE  
 811 or  
 1-800-331-5666  
 WWW.NE-DIGGERS.COM  
 CALL 2 BUSINESS DAYS  
 PRIOR TO ALL WORK

**SHEET 5 OF 8**  
**W-2**

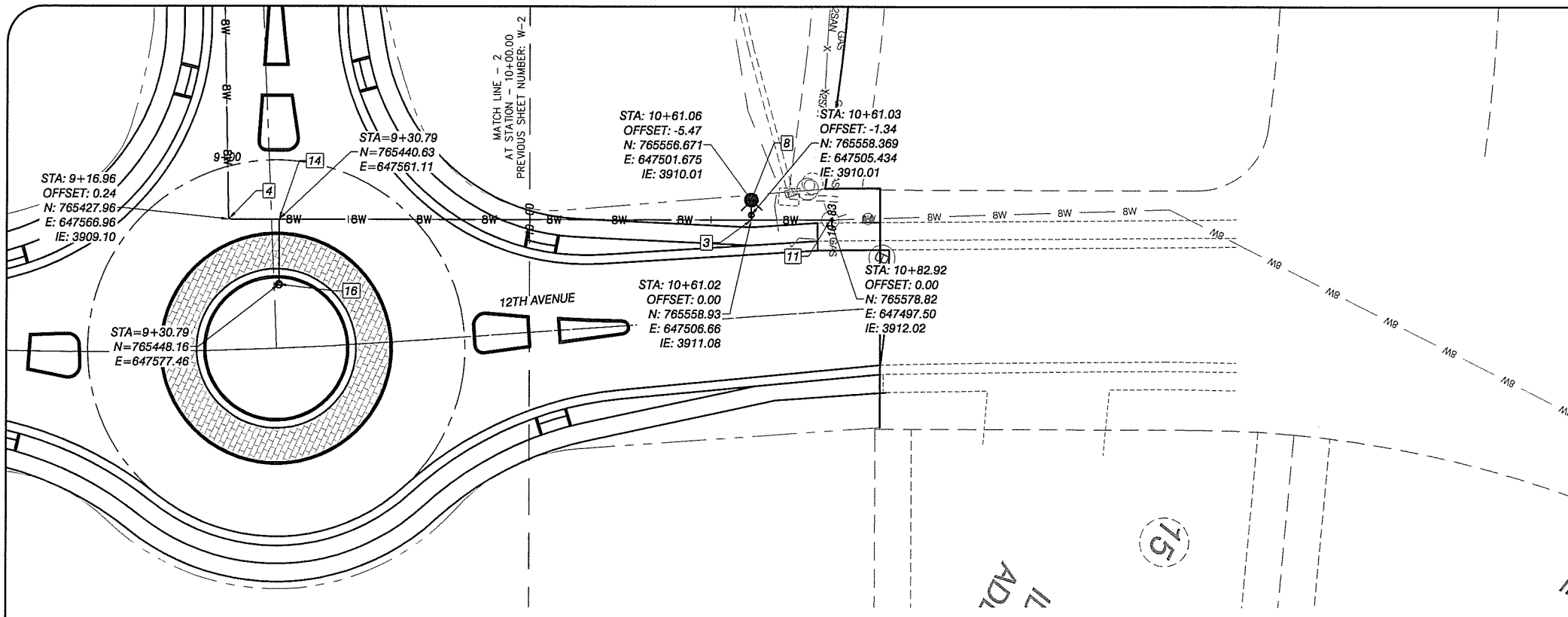

- WATER CONSTRUCTION NOTES:**  
 (NOTE: NOT ALL NOTES ARE USED ON THIS SHEET)
- 1 CONNECT NEW 8" WATERLINE TO EXIST 8" WATERLINE
  - 2 INSTALL 8" GATE VALVE AND VALVE BOX
  - 3 INSTALL 8"x6" TEE
  - 4 INSTALL 8" 90 DEG. HORIZONTAL BEND
  - 5 INSTALL 8" 11.25 DEG. HORIZONTAL BEND
  - 6 INSTALL 8" 45 DEG. HORIZONTAL BEND
  - 7 INSTALL NEW FIRE HYDRANT W/ AUX. VALVE AND VALVE BOX
  - 8 INSTALL RELOCATED FIRE HYDRANT WITH NEW AUX. VALVE AND VALVE BOX
  - 9 INSTALL 8" 22.5 DEG. HORIZONTAL BEND
  - 10 INSTALL 3" SERVICE SADDLE
  - 11 REMOVE & RELOCATE EXISTING FIRE HYDRANT. INSTALL 8"x6" REDUCER
  - 12 CUT & CAP SERVICE LATERAL
  - 13 INSTALL 1" SERVICE SADDLE
  - 14 INSTALL 2" SERVICE SADDLE
  - 15 INSTALL 1" CURB STOP
  - 16 INSTALL 2" CURB STOP

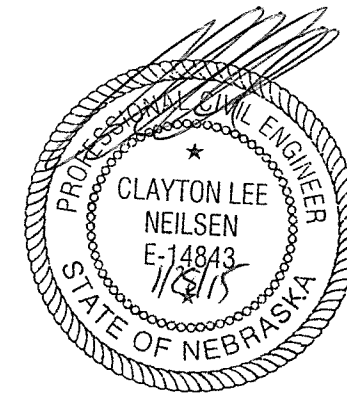

**M. C. SCHAFF & ASSOCIATES, INC.**  
 818 SOUTH BELTLINE HIGHWAY EAST  
 SCOTTSBLUFF, NEBRASKA 69361

ENGINEERS ♦ PLANNERS ♦ DESIGNERS ♦ LAND SURVEYORS  
 PH: 308-635-1926 FAX: 308-635-7807 INTERNET: WWW.MCSCHAFF.COM

**PROJECT:** WATER DISTRICT 105  
 BLOCK 2, REGANIS SUBDIVISION  
 AND BLOCK 1A, SCOTTS BLUFF  
 COUNTY COLLEGE TRACT.  
 PLAN & PROFILE SHEET

**CLIENT:** CITY OF SCOTTSBLUFF

**PROJECT NUMBER:**  
 RM140169-00

**PROJECT DATE:**  
 01-28-15

**PROJECT MGR:**  
 C.L.N.

**PROJECT TEAM:**  
 C.L.N./W.W.

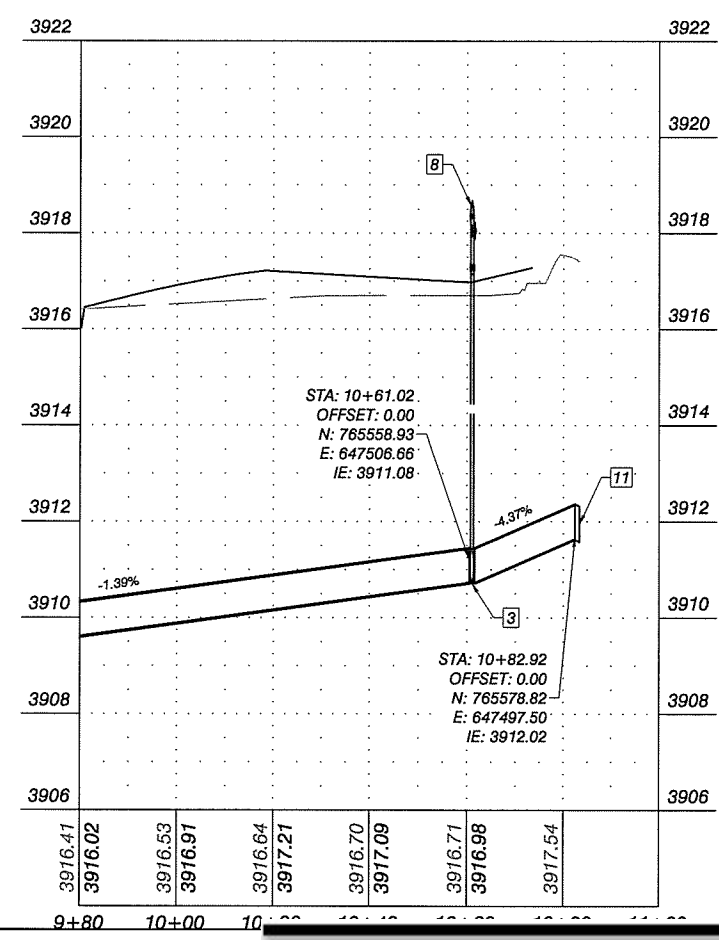

0 20 40  
 Scale in Feet

**PLAN & PROFILE**

DATE	REVISION

CALL BEFORE YOU DIG  
 DIGGER'S HOTLINE  
 811 or  
 1-800-331-5886  
 WWW.NE-DIGGERS.COM  
 CALL 2 BUSINESS DAYS  
 PRIOR TO ALL WORK

**SHEET 6 OF 8**  
**W-3**

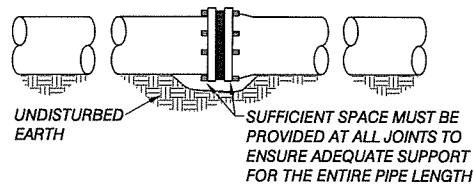

BEDDING DETAIL

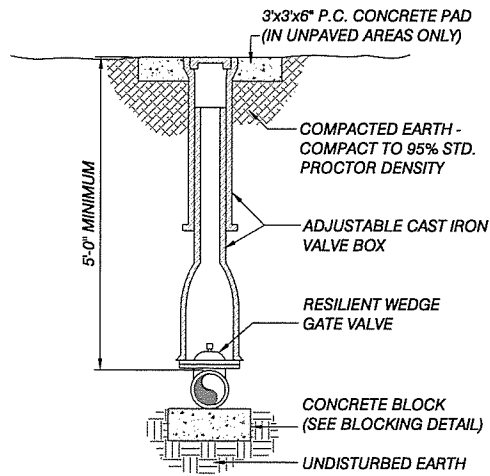

GATE VALVE IN A VALVE BOX

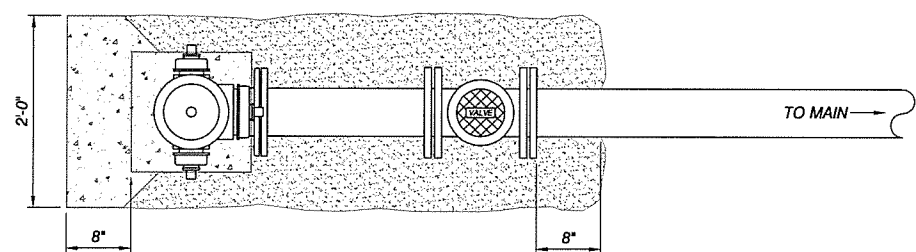

PLAN VIEW

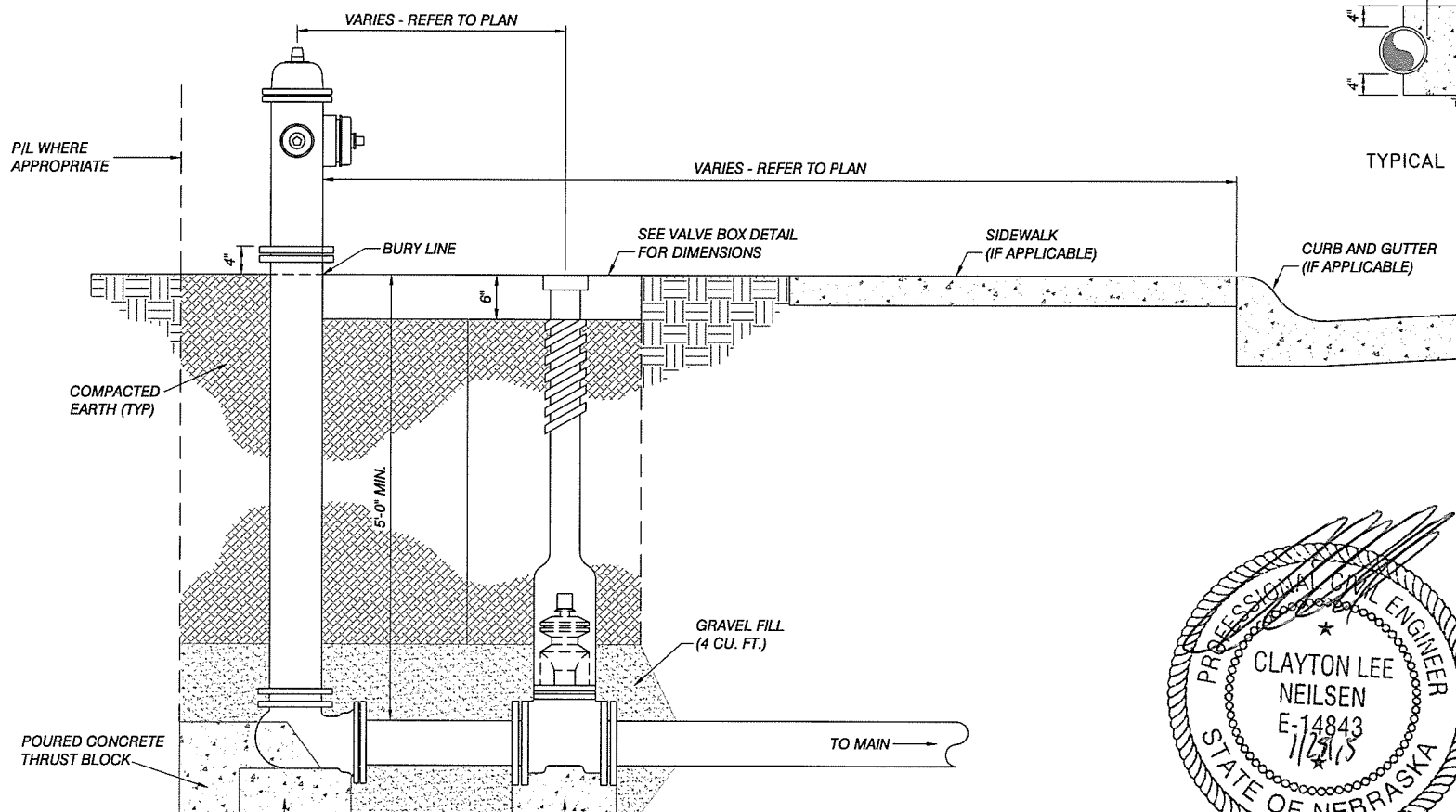

SIDE VIEW  
FIRE HYDRANT SETTING

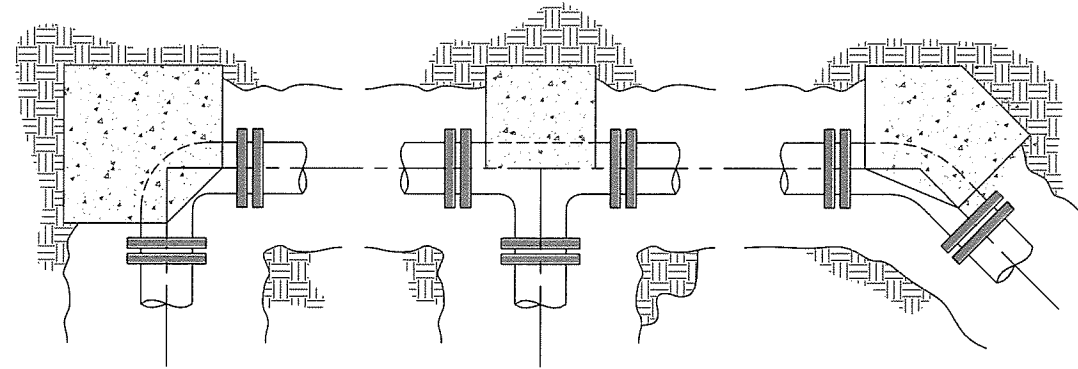

TYPICAL CROSS SECTION OF HORIZONTAL ELBOWS, TEE'S AND BENDS

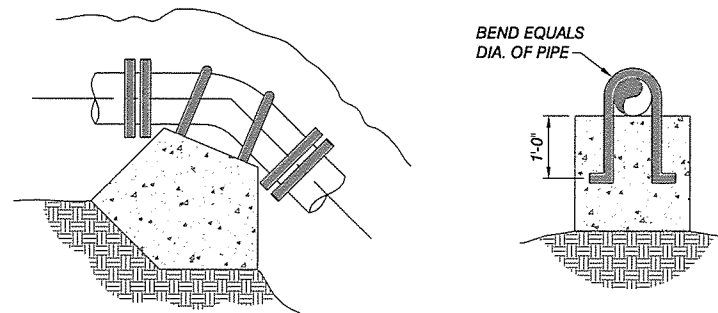

TYPICAL CROSS SECTION OF VERTICAL BEND

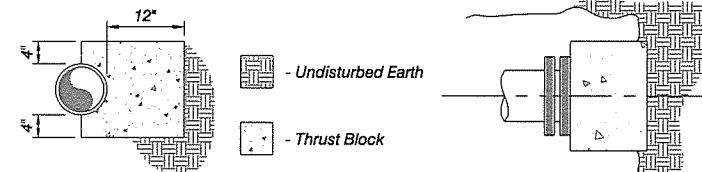

TYPICAL CROSS SECTION

**NOTES:**  
 PLACE DOUBLE LAYER OF TAR PAPER BETWEEN CONCRETE BLOCK AND THE PLUG OR CAP.  
 ALL JOINTS, BOLTS, ETC. SHALL REMAIN FREE FROM CONCRETE AND SHALL BE OTHERWISE ACCESSIBLE.  
 ALL BLOCKS SHALL BE PLACED AGAINST UNDISTURBED EARTH.  
 BLOCKS SHALL BE CAST IN PLACE CONCRETE WITH A MINIMUM COMPRESSIVE STRENGTH OF 2,000 PSI AT 28 DAYS, UNLESS OTHERWISE SPECIFIED.

MINIMUM AREA IN SQUARE FEET OF THRUST BLOCK ON UNDISTURBED TRENCH BANK

PIPE SIZE (INCHES)	90° BEND	45° BEND	DEAD END
4	2	2	2
6	3	3	3
8	5	5	5
10	8	8	8
12	12	12	12
14	16	16	16
16	20	20	20

MINIMUM THICKNESS OF THRUST BLOCK: 18"

WATER MAIN BLOCKING DETAIL

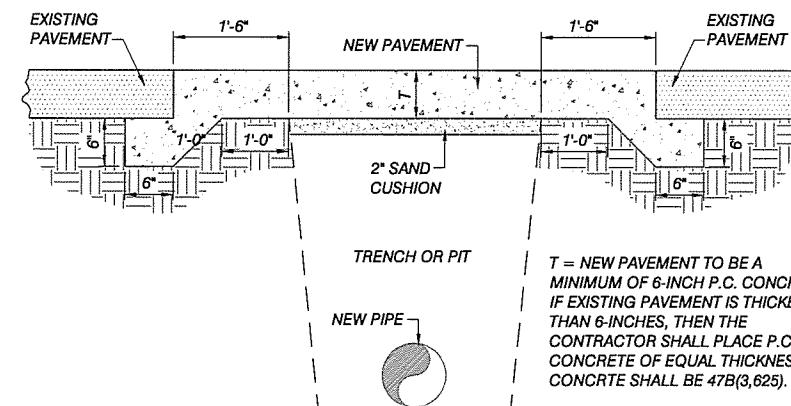

CONCRETE PAVEMENT REPLACEMENT DETAIL

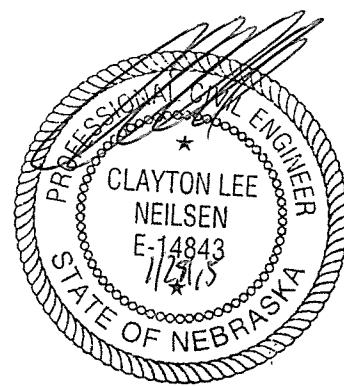

**M. C. SCHAFF & ASSOCIATES, INC.**  
 818 SOUTH BELTLINE HIGHWAY EAST  
 SCOTTSBLUFF, NEBRASKA 69361  
 ENGINEERS ♦ PLANNERS ♦ DESIGNERS ♦ LAND SURVEYORS  
 PH: 308-635-1926 FAX: 308-695-7807 INTERNET: WWW.MCSCHAFF.COM

**PROJECT:** WATER DISTRICT 105  
 BLOCK 2, REGANIS SUBDIVISION  
 AND BLOCK 1A, SCOTTS BLUFF  
 COUNTY COLLEGE TRACT.  
 DETAIL SHEET  
**CLIENT:** CITY OF SCOTTSBLUFF

**PROJECT NUMBER:**  
 RM 140169-00  
**PROJECT DATE:**  
 01-28-15  
**PROJECT MGR:**  
 C.L.N.  
**PROJECT TEAM:**  
 C.L.N./W.W.

SEAL

DATE	REVISION

SHEET 7 OF 8  
**D-1**

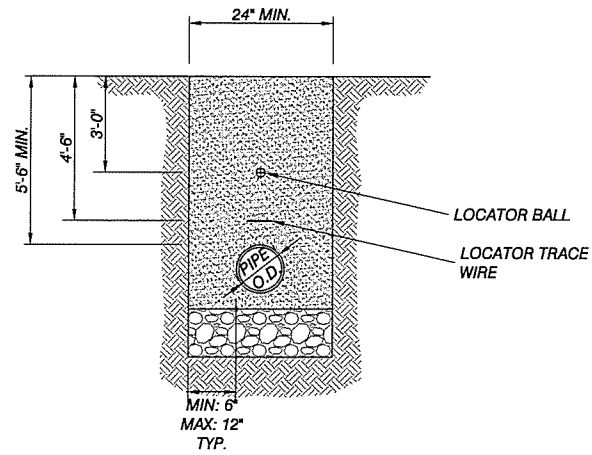

**NOTES:**

1. CENTER PIPE LOCATOR TRACE WIRE IN TRENCH AND PLACE OVER ENTIRE LENGTH OF ALL TYPES, MATERIALS, SIZES AND LOCATIONS OF WATER MAINS.
2. INSTALL LOCATOR BALLS AT ALL HORIZONTAL FITTINGS, REDUCERS, CAPS, TEST STATIONS, AT EACH JOINT OF DEFLECTED SECTIONS OF PIPELINE, AND EVERY 400 FEET OF PIPELINE. LOCATOR BALLS SHALL BE AGENCY APPROVED.

**PIPE LOCATOR RIBBON & LOCATOR BALL INSTALLATION**

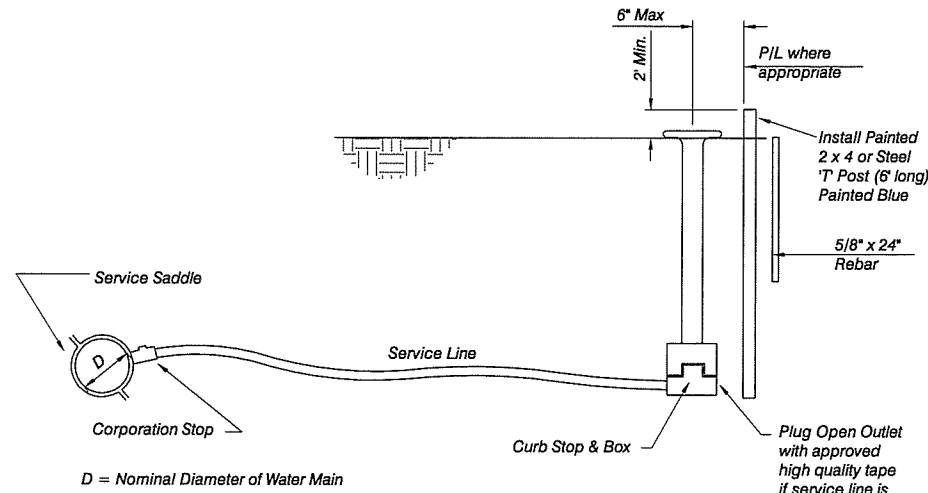

**DETAIL OF WATER SERVICE LINE**

Not to Scale

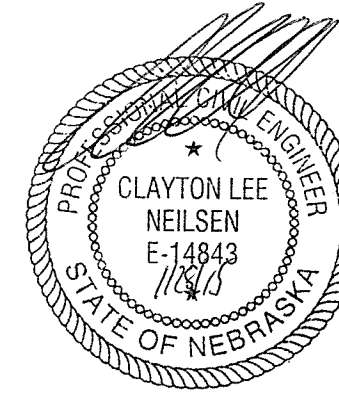

**M. C. SCHAFF & ASSOCIATES, INC.**  
**818 SOUTH BELTLINE HIGHWAY EAST**  
**SCOTTSBLUFF, NEBRASKA 69361**

ENGINEERS ♦ PLANNERS ♦ DESIGNERS ♦ LAND SURVEYORS  
 PH: 308-635-1926 FAX: 308-635-7807 INTERNET: WWW.MCSCHAFF.COM

**PROJECT: WATER DISTRICT 105**  
**BLOCK 2, REGANIS SUBDIVISION**  
**AND BLOCK 1A, SCOTTS BLUFF**  
**COUNTY COLLEGE TRACT.**  
**DETAIL SHEET**

**CLIENT: CITY OF SCOTTSBLUFF**

**PROJECT NUMBER:**  
 RM 140169-00  
**PROJECT DATE:**  
 01-28-15  
**PROJECT MGR:**  
 C.L.N.  
**PROJECT TEAM:**  
 C.L.N./W.W.

SEAL

DATE	REVISION

SHEET 8 OF 8  
**D-2**