City of Grand Island



Tuesday, March 15, 2016
Study Session Packet

City Council:

Linna Dee Donaldson
Michelle Fitzke
Chuck Haase
Julie Hehnke
Jeremy Jones
Vaughn Minton
Mitchell Nickerson
Mike Paulick
Roger Steele
Mark Stelk

Mayor:

Jeremy L. Jensen

City Administrator:

Marlan Ferguson

City Clerk:

RaNae Edwards

7:00 PM
Council Chambers - City Hall
100 East 1st Street

Call to Order

This is an open meeting of the Grand Island City Council. The City of Grand Island abides by the Open Meetings Act in conducting business. A copy of the Open Meetings Act is displayed in the back of this room as required by state law.

The City Council may vote to go into Closed Session on any agenda item as allowed by state law.

Invocation

Pledge of Allegiance

Roll Call

A - SUBMITTAL OF REQUESTS FOR FUTURE ITEMS

Individuals who have appropriate items for City Council consideration should complete the Request for Future Agenda Items form located at the Information Booth. If the issue can be handled administratively without Council action, notification will be provided. If the item is scheduled for a meeting or study session, notification of the date will be given.

B - RESERVE TIME TO SPEAK ON AGENDA ITEMS

This is an opportunity for individuals wishing to provide input on any of tonight's agenda items to reserve time to speak. Please come forward, state your name and address, and the Agenda topic on which you will be speaking.



City of Grand Island

Tuesday, March 15, 2016

Study Session

Item -1

Discussion Regarding Creating a Tree Board

Staff Contact: Todd McCoy, Parks & Recreation Director



Considering a City Tree Board

Why Trees?

Trees intercept and store rain water, relieving stress on municipal storm-water systems and reducing flooding.

Trees increase property values and improve mental health.

Trees provide a barrier to noisy traffic.

Trees shade buildings, reducing the need for air conditioning.

Trees provide habitat for wildlife.

Trees act as a windbreak.

Trees cool outdoor temperatures and protect us from UV rays.

Trees remove carbon dioxide from the air and store it in their wood, leaves and roots.

Trees filter pollutants from the air we breathe and release oxygen.

What is a Tree Board?



A tree board (committee, commission or council) is a group of people responsible, usually by ordinance, for overseeing management of the community trees, also known as the urban forest. It may be made up of municipal staff, local citizens and/or tree care professionals.



What Does a Tree Board Do?

- Assess the community urban forest situation using some type of inventory to determine short- and long-range program goals and objectives.
- Develop and review annually a comprehensive community forestry plan.
- Advise the Mayor, City Council, and various departments on matters concerning trees and related resources. Recommendations may include policy changes and specific urban forestry projects.

What Does a Tree Board Do? (continued)

- Educate residents on matters concerning the betterment of trees and related resources.
- Coordinate or conduct special projects for the betterment of the urban forest. Such projects should be included in annual plans.
- Keep abreast of current trends and issues in urban forestry through appropriate training and development.



Urban Forestry Issues Facing Grand Island

- Needed planning and education regarding looming diseases and threats to trees in Grand Island.
 - The Emerald Ash Borer, Pine Wilt, Oak Wilt, and other diseases have or soon will have a dramatic impact to the our communities urban forest.
- The City is not heavily involved in promoting or managing street trees. That is an important issue that a tree board could help wrestle with.
- Tree inventory: The City does not have a recently updated tree inventory. That could be a responsibility of the tree board.
- Overreliance on Hackberries as a street and park tree in Grand Island.
 - As time goes forward it would be very important to start increasing species diversity.

ORDINANCE NO. 6260

An ordinance to amend Chapter 23 of the Grand Island City Code by adding thereto Article IV pertaining to the creation of a Tree Board, its composition, its duties and responsibilities, and operation thereof; to repeal conflicting ordinances; and to provide the effective date hereof.

BE IT ORDAINED BY THE MAYOR AND COUNCIL OF THE CITY OF GRAND ISLAND, NEBRASKA:

SECTION 1. That Chapter 23 of the Grand Island City Code be amended by adding thereto Article IV to read as follows:

"Article IV

CITY TREE BOARD

"Sec. 23-13. CREATION AND ESTABLISHMENT

There is hereby created and established a City Tree Board for the City of Grand Island, Nebraska, which shall consist of six members, citizens and residents of the City who shall be appointed by the Mayor with the approval of the Council, which board shall act in an advisory capacity to the Mayor and Council."

"Sec. 23-14. TERM OF OFFICE; COMPENSATION

The term of the six persons to be appointed by the Mayor shall be three years, except that the term of two of the members appointed to the first board shall be for only one year, and the term of two of the members of the board shall be for two years. In the event that a vacancy shall occur during the term of any member, his successor shall be appointed for the unexpired portion of the term.

Members of the board shall serve without compensation."

"Sec. 23-15. DUTIES AND RESPONSIBILITIES

It shall be the responsibility of the board to study, investigate, counsel, and develop a written plan for the care, preservation, trimming, planting, replanting, removal or disposition of trees and shrubs in public ways, streets and alleys. Such plans shall be presented to the City Council and upon their acceptance and approval shall constitute the official comprehensive city tree plan for the City of Grand Island, Nebraska. The board shall review annually and update if needed, the comprehensive city tree plan. The board shall prepare and present an annual work plan to the City Council for their acceptance and approval.

The board when requested by the City Council shall consider, investigate, make findings, report and recommend upon any special matter of question coming within the scope of its work."

"Sec. 23-16. OPERATION

The board shall choose its own officers, make its own rules and regulations

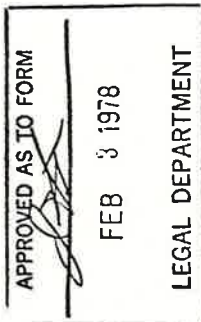

ORDINANCE NO. 6260 (Cont'd)

and keep a journal of its proceedings. A majority of its members shall be a quorum for the transaction of business."

SECTION 2. Any ordinances or parts of ordinances in conflict herewith, be, and hereby are, repealed.

SECTION 3. This ordinance shall be in force and take effect from and after its passage, approval, and publication within fifteen days in one issue of the Grand Island Daily Independent, as provided by law.

Enacted FEB 6 1978.



President of the Council

ATTEST: 
City Clerk



City of Grand Island

Tuesday, March 15, 2016

Study Session

Item -2

Grand Island Electric Generation Update

Staff Contact: Tim Luchsinger, Utilities Director

Council Agenda Memo

From: Timothy Luchsinger, Utilities Director
Meeting: March 15, 2016
Subject: Grand Island Electric Generation Update
Presenter(s): Timothy Luchsinger, Utilities Director

Background

The EPA Clean Power Plan is one of the primary drivers of electric generation strategy in the United States. The purpose of this regulation is to reduce carbon dioxide emissions by about 30 percent by 2030.

Discussion

This presentation will provide background on the Utilities Department's current and planned electric generation plans.

Conclusion

This item is presented to the City Council in a Study Session to allow for any questions to be answered and to create a greater understanding of the issue at hand.

Grand Island Electric Generation Past, Present, & Future

Grand Island City Council Study Session
March 15, 2016



Clean Air Act Section 111(d) Clean Power Plan

- Rule to be published August, 2015
- Establishes greenhouse gas emission goals by state, 40% reduction proposed for Nebraska
- State plans to be submitted to EPA by September, 2016 for achieving emission targets for 2020-2029 and 2030+
- Rule currently stayed by Supreme Court

Clean Power Plan

- Reduce greenhouse gas emissions through the following “building blocks”
 - Improve existing coal power plant efficiencies
 - Increase natural gas combined cycle generation
 - Increase use of renewable energy sources (Renewable Energy Credits)
 - Implementation of demand-side energy reduction programs originally proposed but not in final rule

Grand Island Wind Participation - Current

- NPPD Power Purchase Agreements with GIUD participation agreements
 - Ainsworth – 1 megawatt (MW)
 - Elkhorn Ridge – 1 MW
 - Laredo Ridge – 1 MW
 - Broken Bow – 1 MW
 - Springview 2 – minimal output – access to data

Grand Island Wind Participation-Planned

- Prairie Breeze III – 35.8 MW (Commercial March 2016)
- Antelope County – 40 MW (Proposed for end of 2016)

Power Purchase Agreement

- Agreement term is 25 years
- Commercial operation by 4th quarter 2016
- Firm energy cost with annual escalation
- Cost paid on energy produced, no upfront cost
- Power Purchase Agreement executed by GIUD and Invenergy

Capacity Additions

	Year	Capacity	Cost
Platte Generating Station	1982	100 MW	\$80M
Burdick Gas Turbines 2 & 3	2003	68 MW	\$50M
Nebraska City Unit 2	2009	35 MW	\$40M
Whelan Energy Center Unit 2	2011	15 MW	\$40M

Grand Island Utilities Historical Generating Capacity

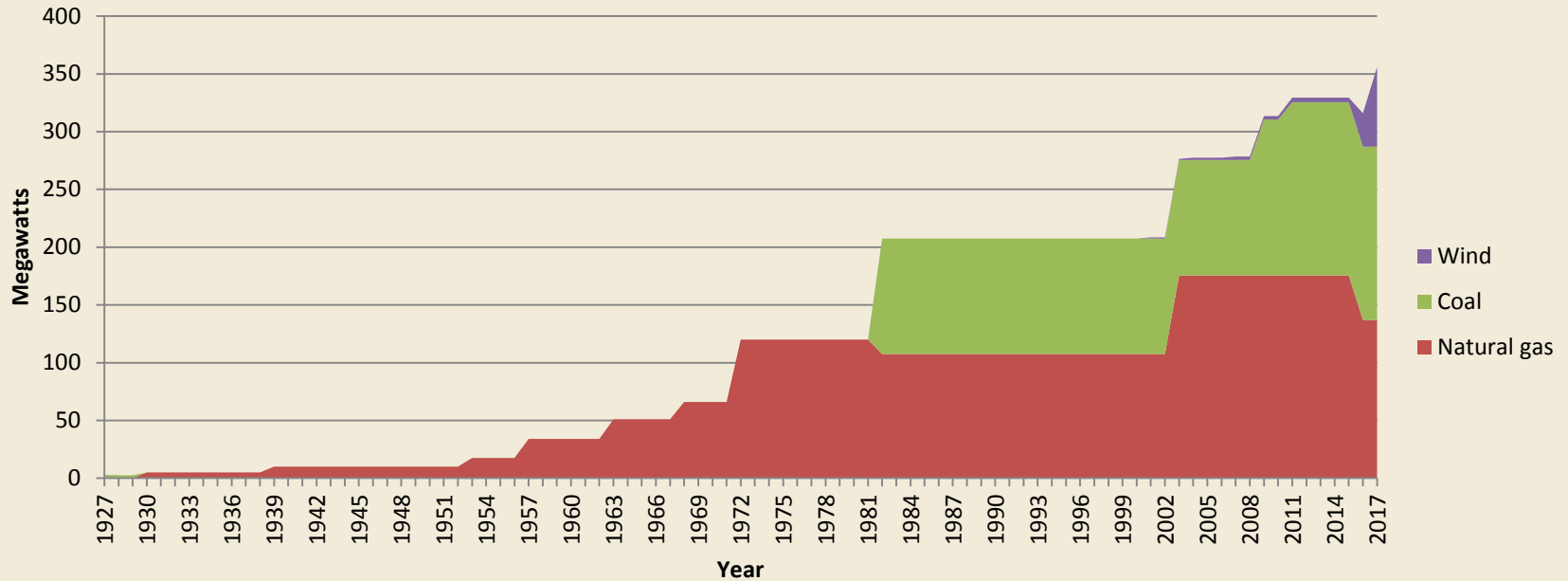

Generation Source Ratio

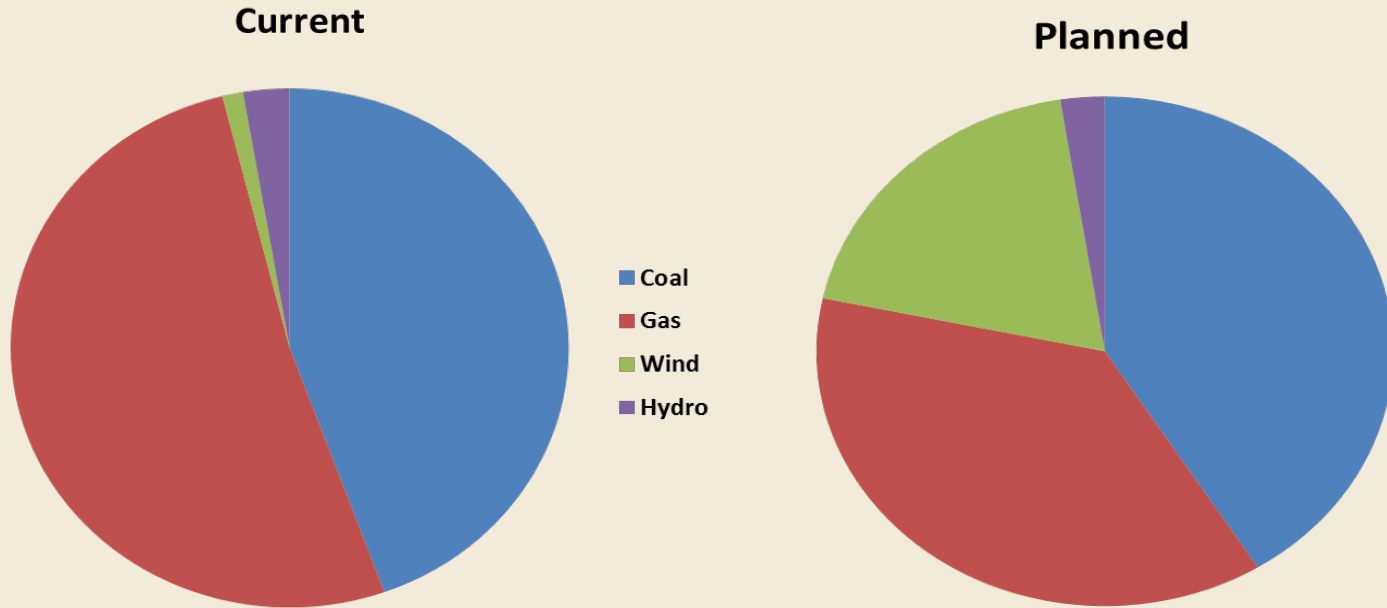

Energy Ratio

Current

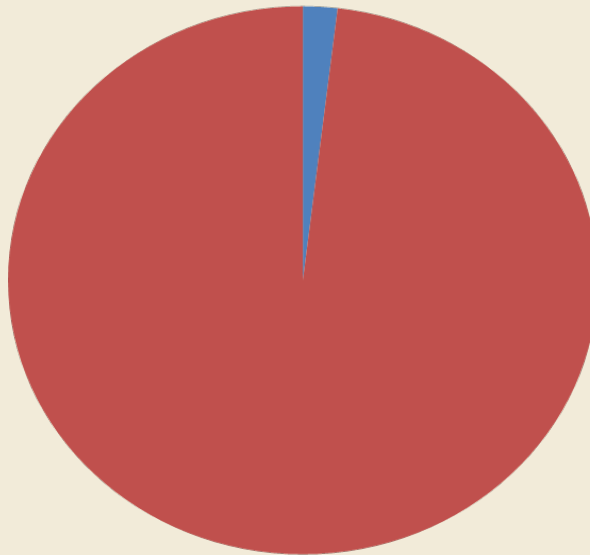

Proposed

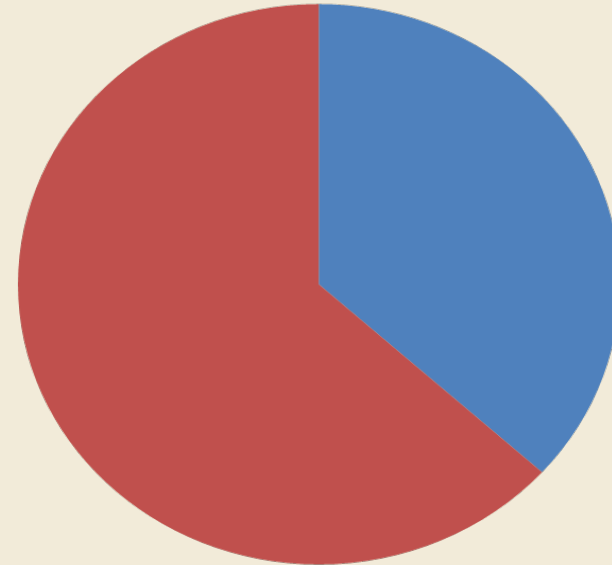

■ Renewables
■ Fossil Fuels























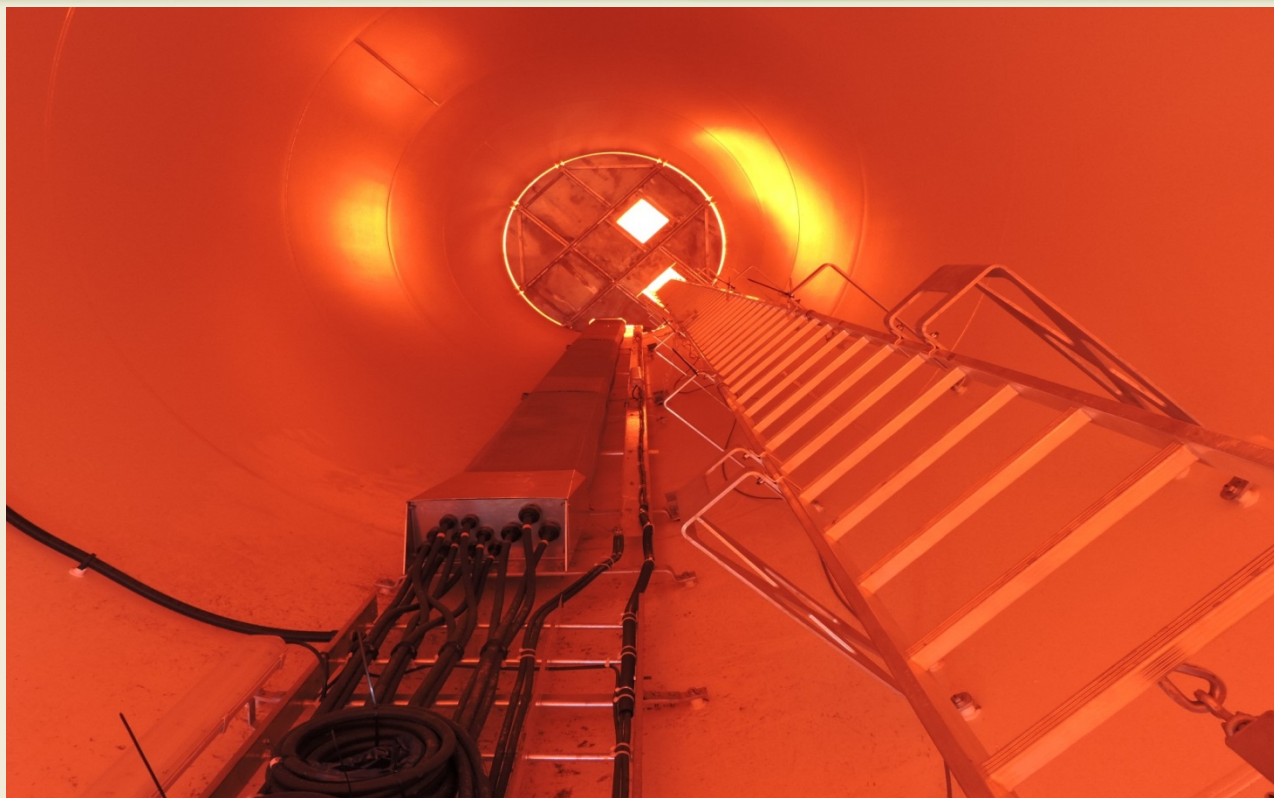

Number of Turbines Available	0
Number of Turbines Online	0
Wind Speed	4.20 m/s
Wind Direction	252 °
Temperature	56.7 °F
Barometric Pressure	93.56 kPa
Humidity	46.0 %

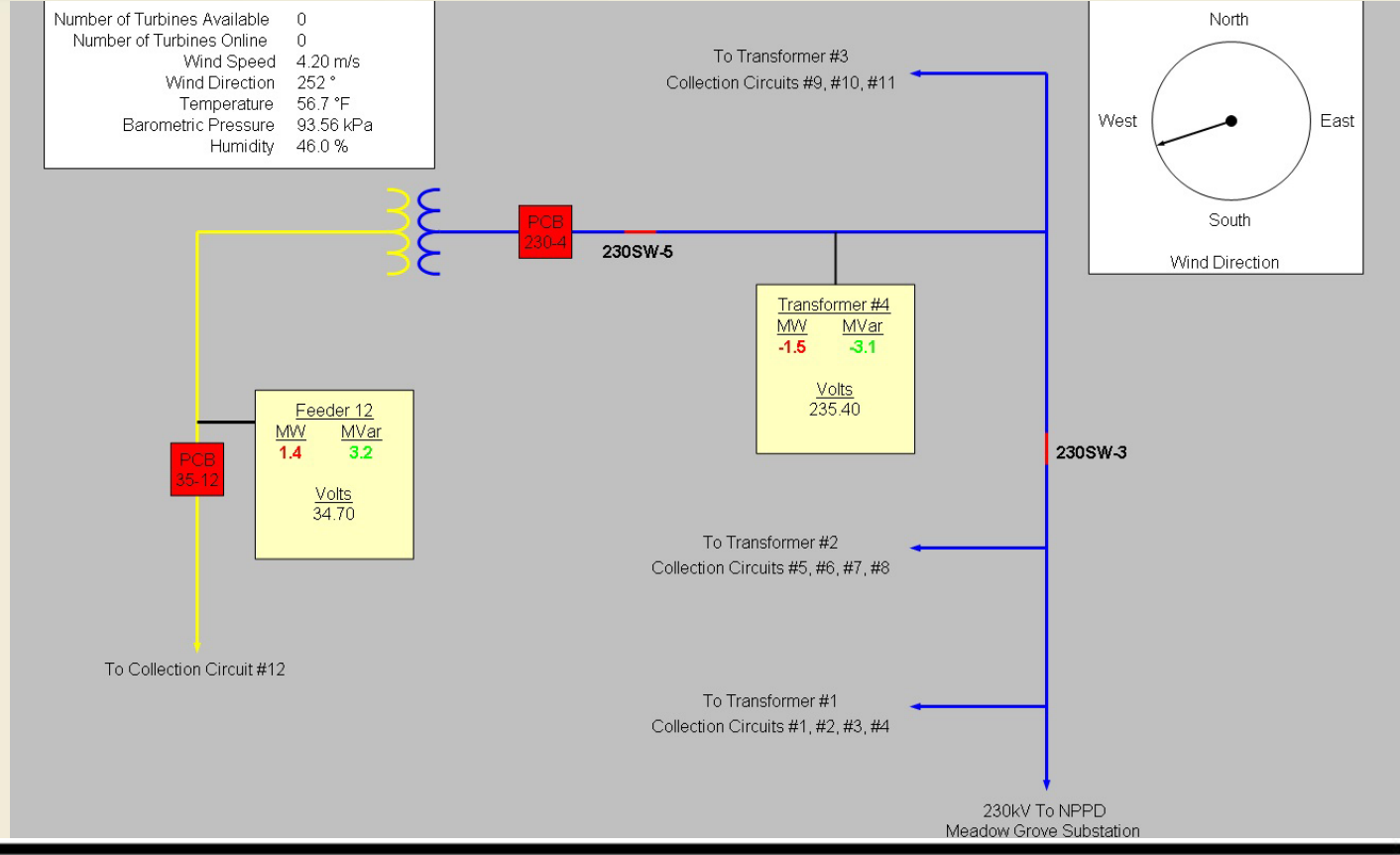
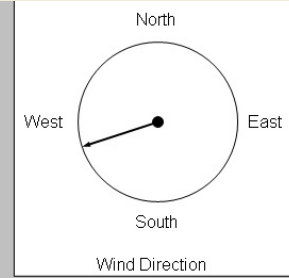

Discussion / Questions

